



ACPI Component Architecture Programmer Reference

Core Subsystem, Debugger, and Utilities

Revision 1.16

April 18, 2003





Information in this document is provided in connection with Intel® products. No license, express or implied, by estoppel or otherwise, to any intellectual property rights is granted by this document. Except as provided in Intel's Terms and Conditions of Sale for such products, Intel assumes no liability whatsoever, and Intel disclaims any express or implied warranty, relating to sale and/or use of Intel products including liability or warranties relating to fitness for a particular purpose, merchantability, or infringement of any patent, copyright or other intellectual property right. Intel products are not intended for use in medical, life saving, or life sustaining applications.

Intel may make changes to specifications and product descriptions at any time, without notice.

Designers must not rely on the absence or characteristics of any features or instructions marked "reserved" or "undefined." Intel reserves these for future definition and shall have no responsibility whatsoever for conflicts or incompatibilities arising from future changes to them.

The <Product Name> may contain design defects or errors known as errata which may cause the product to deviate from published specifications. Current characterized errata are available on request.

Copyright © 2000 - 2003 Intel Corporation

*Other brands and names are the property of their respective owners.

Contents

1	Introduction.....	11
1.1	Document Structure	11
1.2	Rationale and Justification	11
1.3	Reference Documents.....	12
1.4	Overview of the ACPI Component Architecture	12
1.5	Overview of the ACPI Core Subsystem	13
1.5.1	ACPI Core Subsystem	14
1.5.2	Operating System Services Layer.....	14
1.5.3	Relationships Between the Host OS, Core Subsystem, and OSL.....	15
1.5.3.1	Host Operating System Interaction.....	15
1.5.3.2	OS Services Layer Interaction.....	15
1.5.3.3	ACPI Core Subsystem Interaction.....	16
1.6	Architecture of the ACPI Core Subsystem	17
1.6.1	AML Interpreter	17
1.6.2	ACPI Table Management.....	17
1.6.3	Namespace Management	18
1.6.4	Resource Management.....	18
1.6.5	ACPI Hardware Management	18
1.6.6	Event Handling.....	18
1.7	Architecture of the OS Services Layer (OSL)	19
1.7.1	Functional Service Groups	19
1.7.1.1	OS Bootload-Time Services	20
1.7.1.2	Device Driver Load-Time Services	20
1.7.1.3	OS Run-Time Services.....	20
1.7.1.4	Asynchronous Services	20
1.7.2	Required Functionality.....	20
1.7.2.1	Requests from OS to ACPI Subsystem.....	20
1.7.2.2	Requests from Application to ACPI Subsystem	21
1.7.2.3	Requests from ACPI Subsystem to OS.....	21
2	Design Overview	23
2.1	ACPI Namespace Fundamentals.....	23
2.1.1	Named Objects.....	23
2.1.2	Scopes.....	23
2.1.3	Predefined Objects.....	24
2.1.4	Logical Namespace Layout.....	24
2.2	Execution Model.....	25
2.2.1	Initialization.....	25
2.2.2	Memory Allocation	25
2.2.2.1	Caller Allocates All Buffers	26
2.2.2.2	ACPI Allocates Return Buffers	26
2.2.3	Parameter Validation.....	27
2.2.4	Exception Handling	27
2.2.5	Multitasking and Reentrancy	27
2.2.6	Event Handling.....	27
2.2.6.1	Fixed Events	28
2.2.6.2	General Purpose Events	28
2.2.6.3	Notify Events.....	28
2.2.7	Address Spaces and Operation Regions.....	28
2.2.7.1	Installation of Address Space Handlers.....	29
2.2.7.2	ACPI-Defined Address Spaces	29

2.3	Policies and Philosophies.....	30
2.3.1	External Interfaces	30
2.3.1.1	Exception Codes.....	30
2.3.1.2	Memory Buffers	30
2.3.2	Subsystem Initialization.....	30
2.3.2.1	ACPI Table Validation.....	30
2.3.2.2	Required ACPI Tables.....	31
3	Design and Implementation Details.....	32
3.1	Required Host OS Initialization Sequence	32
3.1.1	Bootload and Low Level Kernel Initialization	32
3.1.2	ACPI CA Subsystem Initialization	32
3.1.3	Other OS Initialization	32
3.1.4	Device Enumeration, Configuration, and Initialization	32
3.1.5	Final OS Initialization.....	33
3.2	Required ACPI CA Initialization Sequence	33
3.2.1	ACPI CA Subsystem Initialization	33
3.2.1.1	AcpiInitializeSubsystem	33
3.2.2	ACPI Table and Namespace Initialization.....	33
3.2.2.1	AcpiLoadFirmwareTables	33
3.2.2.2	AcpiLoadTable.....	33
3.2.2.3	Internal ACPI Namespace Initialization	34
3.2.3	Handler Installation.....	34
3.2.3.1	Handler Types	34
3.2.4	Subsystem Initialization Completion	34
3.2.4.1	AcpiEnableSubsystem.....	34
3.2.4.2	ACPI Hardware and Event Initialization.....	35
3.2.4.3	Just-in-time Address Space Initialization.....	35
3.2.4.4	AcpiInitializeObjects	36
3.2.4.5	Other Operating System ACPI-related Initialization	36
3.2.5	System Shutdown	37
3.2.5.1	AcpiTerminate.....	37
3.3	Multithreading Support	37
3.3.1	Reentrancy	37
3.3.2	Control Method Execution	37
3.3.2.1	Control Method Blocking	37
3.3.2.2	Control Method Execution Rules	38
3.3.2.3	A Simple Multithreading Model.....	38
3.3.2.4	A More Complex Multithreading Model	39
3.3.3	Global Lock Support.....	40
3.3.3.1	Obtaining The Global Lock	41
3.3.3.2	Releasing the Global Lock.....	41
3.3.3.3	Global Lock Interrupt Handler.....	42
3.3.4	Single Thread Environments	42
3.4	Debugging Support	42
3.4.1	Function Tracing (ACPI_FUNCTION_TRACE Macro).....	42
3.4.2	Execution Debug Output (ACPI_DEBUG_PRINT Macro)	43
3.4.3	ACPI Debugger	44
3.5	Environmental Support Requirements	44
3.5.1	Resource Requirements.....	44
3.5.2	C Library Functions	44
3.5.3	System Include Files	45
3.5.3.1	Customization to the Target Environment	45
4	Interface Parameters and Data Types	47
4.1	ACPI Subsystem Interface Parameters	47



- 4.1.1 ACPI Names and Pathnames 47
- 4.1.2 Pointers 47
- 4.1.3 Buffers 47
- 4.2 ACPI Subsystem Data Types..... 48
 - 4.2.1 UINT64 and COMPILER_DEPENDENT_UINT64 48
 - 4.2.2 ACPI_PHYSICAL_ADDRESS..... 48
 - 4.2.3 ACPI_POINTER 48
 - 4.2.4 ACPI_INTEGER 48
 - 4.2.5 ACPI_STRING – ASCII String 48
 - 4.2.6 ACPI_BUFFER – Input and Output Memory Buffers 48
 - 4.2.6.1 Input Buffer 49
 - 4.2.6.2 Output Buffer 49
 - 4.2.7 ACPI_HANDLE – Object Handle 49
 - 4.2.7.1 Predefined Handles 50
 - 4.2.8 ACPI_OBJECT_TYPE – Object Type Codes 50
 - 4.2.9 ACPI_OBJECT – Method Parameters and Return Objects..... 50
 - 4.2.10 ACPI_OBJECT_LIST – List of Objects 52
 - 4.2.11 ACPI_EVENT_TYPE – Fixed Event Type Codes..... 52
 - 4.2.12 ACPI_TABLE_TYPE – ACPI Table Type Codes 52
 - 4.2.13 ACPI_TABLE_HEADER – Common ACPI Table Header 52
 - 4.2.14 ACPI_STATUS – Interface Exception Return Codes 53
- 4.3 ACPI Resource Data Types 53
 - 4.3.1 PCI IRQ Routing Tables..... 53
 - 4.3.2 Device Resources 54
 - 4.3.2.1 RESOURCE_TYPE – Resource Data Types..... 54
- 4.4 Exception Codes 56
- 5 Subsystem Configuration..... 59**
 - 5.1 Configuration Files 59
 - 5.2 Per-Compiler Configuration..... 59
 - 5.2.1 ACPI_DIV_64_BY_32 (Short 64-bit Divide)..... 59
 - 5.2.2 ACPI_SHIFT_RIGHT_64 (64-bit Shift)..... 59
 - 5.2.3 ACPI_EXTERNAL_XFACE 59
 - 5.2.4 ACPI_INTERNAL_XFACE 60
 - 5.2.5 ACPI_INTERNAL_VAR_XFACE..... 60
 - 5.2.6 ACPI_SYSTEM_XFACE 60
 - 5.2.7 ACPI_PRINTF_LIKE_FUNC 60
 - 5.2.8 ACPI_UNUSED_VAR 60
 - 5.2.9 COMPILER_DEPENDENT_INT64 60
 - 5.2.10 COMPILER_DEPENDENT_UINT64..... 60
 - 5.3 Per-Machine Configuration..... 60
 - 5.3.1 ACPI_ASM_MACROS 60
 - 5.3.2 ACPI_FLUSH_CPU_CACHE..... 61
 - 5.3.3 ACPI_MACHINE_WIDTH..... 61
 - 5.3.4 ACPI_OS_NAME 61
 - 5.3.5 ACPI_USE_STANDARD_HEADERS 61
 - 5.3.6 ACPI_ACQUIRE_GLOBAL_LOCK 61
 - 5.3.7 ACPI_RELEASE_GLOBAL_LOCK..... 61
 - 5.4 Other Compile-time Configuration..... 61
 - 5.4.1 ACPI_APPLICATION 61
 - 5.4.2 ACPI_DEBUG 61
 - 5.4.3 PARSER_ONLY..... 62
 - 5.5 Configuration of Subsystem Constants..... 62
 - 5.5.1 MAX_STATE_CACHE_DEPTH..... 62
 - 5.5.2 MAX_PARSE_CACHE_DEPTH 62

5.5.3	MAX_OBJECT_CACHE_DEPTH	62
5.5.4	MAX_WALK_CACHE_DEPTH	62
6	ACPI Core Subsystem - External Interface Definition	63
6.1	Subsystem Initialization, Shutdown, and Status	63
6.1.1	AcpiInitializeSubsystem	63
6.1.2	AcpiInstallInitializationHandler	64
6.1.2.1	Interface to User Callback Function	64
6.1.3	AcpiEnableSubsystem	65
6.1.4	AcpiInitializeObjects	66
6.1.5	AcpiGetSystemInfo	66
6.1.6	AcpiSubsystemStatus	68
6.1.7	AcpiFormatException	69
6.1.8	AcpiPurgeCachedObjects	69
6.1.9	AcpiTerminate	70
6.2	Memory Management	71
6.2.1	AcpiAllocate	71
6.2.2	AcpiCalloc	71
6.2.3	AcpiFree	72
6.3	ACPI Hardware Management	73
6.3.1	AcpiEnable	73
6.3.2	AcpiDisable	73
6.3.3	AcpiGetRegister	74
6.3.4	AcpiSetRegister	75
6.3.5	AcpiSetFirmwareWakingVector	76
6.3.6	AcpiGetFirmwareWakingVector	77
6.3.7	AcpiGetSleepTypeData	78
6.3.8	AcpiEnterSleepStatePrep	79
6.3.9	AcpiEnterSleepState	79
6.3.10	AcpiLeaveSleepState	80
6.3.11	AcpiAcquireGlobalLock	80
6.3.12	AcpiReleaseGlobalLock	81
6.3.13	AcpiGetTimerResolution	82
6.3.14	AcpiGetTimerDuration	82
6.3.15	AcpiGetTimer	83
6.4	ACPI Table Management	84
6.4.1	AcpiGetFirmwareTable	84
6.4.2	AcpiFindRootPointer	85
6.4.3	AcpiLoadTables	86
6.4.4	AcpiLoadTable	87
6.4.5	AcpiUnloadTable	88
6.4.6	AcpiGetTableHeader	88
6.4.7	AcpiGetTable	89
6.5	ACPI Namespace Access	91
6.5.1	AcpiEvaluateObject	91
6.5.2	AcpiGetObjectInfo	95
6.5.3	AcpiGetNextObject	97
6.5.4	AcpiGetParent	98
6.5.5	AcpiGetType	99
6.5.6	AcpiGetHandle	99
6.5.7	AcpiGetName	101
6.5.8	AcpiGetDevices	102
6.5.9	AcpiAttachData	103
6.5.10	AcpiDetachData	104
6.5.11	AcpiGetData	105
6.5.12	AcpiWalkNamespace	106



	6.5.12.1	Interface to User Callback Function	107
6.6		ACPI Resource Management.....	108
	6.6.1	AcpiGetCurrentResources	108
	6.6.2	AcpiGetPossibleResources.....	109
	6.6.3	AcpiSetCurrentResources.....	110
	6.6.4	AcpiGetIRQRoutingTable.....	111
	6.6.5	AcpiWalkResources	112
	6.6.5.1	Interface to User Callback Function	113
6.7		ACPI Fixed Event Management.....	114
	6.7.1	AcpiEnableEvent	114
	6.7.2	AcpiDisableEvent	115
	6.7.3	AcpiClearEvent.....	115
	6.7.4	AcpiGetEventStatus	116
	6.7.5	AcpiInstallFixedEventHandler	117
	6.7.5.1	Interface to Fixed Event Handlers	118
	6.7.6	AcpiRemoveFixedEventHandler	118
6.8		ACPI General Purpose Event Management	120
	6.8.1	AcpiInstallGpeBlock	120
	6.8.2	AcpiRemoveGpeBlock	121
	6.8.3	AcpiEnableGpe	121
	6.8.4	AcpiClearGpe	122
	6.8.5	AcpiGetGpeStatus.....	123
	6.8.6	AcpiDisableGpe.....	124
	6.8.7	AcpiInstallGpeHandler.....	126
	6.8.7.1	Interface to General Purpose Event Handlers.....	127
	6.8.8	AcpiRemoveGpeHandler.....	127
6.9		ACPI Miscellaneous Handler Support.....	129
	6.9.1	AcpiInstallNotifyHandler	129
	6.9.1.1	Interface to Notification Event Handlers	130
	6.9.2	AcpiRemoveNotifyHandler	131
	6.9.3	AcpiInstallAddressSpaceHandler	132
	6.9.3.1	Interface to Address Space Setup Handlers	133
	6.9.3.2	Interface to Address Space Handlers.....	134
	6.9.3.3	Context for the Default PCI Address Space Handler	135
	6.9.4	AcpiRemoveAddressSpaceHandler.....	135
7		OS Services Layer - External Interface Definition.....	137
	7.1	Environmental	137
	7.1.1	AcpiOsInitialize	137
	7.1.2	AcpiOsTerminate.....	137
	7.1.3	AcpiOsGetRootPointer	138
	7.1.4	AcpiOsPredefinedOverride.....	139
	7.1.5	AcpiOsTableOverride	139
	7.2	Memory Management	140
	7.2.1	AcpiOsMapMemory.....	140
	7.2.2	AcpiOsUnmapMemory	141
	7.2.3	AcpiOsGetPhysicalAddress	141
	7.2.4	AcpiOsAllocate	142
	7.2.5	AcpiOsFree	142
	7.2.6	AcpiOsReadable	143
	7.2.7	AcpiOsWritable.....	143
	7.3	Multithreading and Scheduling Services	144
	7.3.1	AcpiOsGetThreadId.....	144
	7.3.2	AcpiOsQueueForExecution.....	144
	7.3.3	AcpiOsSleep.....	145

7.3.4	AcpiOsStall.....	146
7.4	Mutual Exclusion and Synchronization	146
7.4.1	AcpiOsCreateSemaphore	147
7.4.2	AcpiOsDeleteSemaphore.....	148
7.4.3	AcpiOsWaitSemaphore.....	148
7.4.4	AcpiOsSignalSemaphore	149
7.4.5	AcpiOsCreateLock	150
7.4.6	AcpiOsDeleteLock.....	150
7.4.7	AcpiOsAcquireLock.....	151
7.4.8	AcpiOsReleaseLock.....	152
7.5	Interrupt Handling.....	152
7.5.1	AcpiOsInstallInterruptHandler	153
7.5.1.1	Interface to OS-independent Interrupt Handlers	154
7.5.2	AcpiOsRemoveInterruptHandler	154
7.6	Address Space Access	155
7.6.1	Memory and Memory Mapped I/O	155
7.6.1.1	AcpiOsReadMemory.....	155
7.6.1.2	AcpiOsWriteMemory.....	156
7.6.2	Port Input/Output.....	156
7.6.2.1	AcpiOsReadPort.....	156
7.6.2.2	AcpiOsWritePort.....	157
7.6.3	PCI Configuration Space.....	157
7.6.3.1	AcpiOsReadPciConfiguration.....	158
7.6.3.2	AcpiOsWritePciConfiguration	158
7.6.3.3	AcpiOsDerivePcild.....	159
7.7	Stream I/O.....	160
7.7.1	AcpiOsPrintf	160
7.7.2	AcpiOsVprintf	160
7.7.3	AcpiOsRedirectOutput.....	161
7.8	Miscellaneous.....	161
7.8.1	AcpiOsSignal.....	161
7.8.1.1	ACPI_SIGNAL_FATAL.....	162
7.8.1.2	ACPI_SIGNAL_BREAKPOINT.....	162
7.8.2	AcpiOsGetLine	162
8	ACPI Debugger	164
8.1	Overview.....	164
8.2	Supported Environments.....	164
8.2.1	The AcpiExec Utility	164
8.3	Debugger Architecture	164
8.4	Configuration and Installation.....	165
8.5	Debugger Commands	167
8.5.1	General Purpose Commands.....	167
8.5.1.1	Allocations	167
8.5.1.2	Dump	167
8.5.1.3	Exit.....	168
8.5.1.4	Help.....	168
8.5.1.5	History (! And !!).....	168
8.5.1.6	Level	168
8.5.1.7	Quit	169
8.5.1.8	Stats.....	169
8.5.1.9	Unload	169
8.5.2	Namespace Access Commands.....	169
8.5.2.1	Event.....	169
8.5.2.2	Find.....	170



- 8.5.2.3 Methods 170
- 8.5.2.4 Namespace..... 170
- 8.5.2.5 Notify..... 170
- 8.5.2.6 Object 171
- 8.5.2.7 Owner 171
- 8.5.2.8 Prefix..... 171
- 8.5.2.9 References 171
- 8.5.2.10 Resources..... 171
- 8.5.2.11 Terminate..... 172
- 8.5.2.12 Thread 172
- 8.5.3 Control Method Execution Commands 172
 - 8.5.3.1 Arguments 172
 - 8.5.3.2 Breakpoint..... 172
 - 8.5.3.3 Call..... 173
 - 8.5.3.4 Debug 173
 - 8.5.3.5 Execute..... 173
 - 8.5.3.6 Go 173
 - 8.5.3.7 Gpe 173
 - 8.5.3.8 Gpes 174
 - 8.5.3.9 Information..... 174
 - 8.5.3.10 Into..... 174
 - 8.5.3.11 List 174
 - 8.5.3.12 Locals 175
 - 8.5.3.13 Results..... 175
 - 8.5.3.14 Set..... 176
 - 8.5.3.15 Stop..... 176
 - 8.5.3.16 Tree..... 176
- 8.5.4 File I/O Commands 176
 - 8.5.4.1 Close..... 176
 - 8.5.4.2 Load..... 177
 - 8.5.4.3 Open 177
- 9 Tools and Utilities 178**
 - 9.1 AcpiDump..... 178
 - 9.2 AcpiExec..... 178
 - 9.3 WDM Driver and Test Application 178
- 10 Subsystem User Guide 179**
 - 10.1 Using the ACPI Core Subsystem Interfaces 179
 - 10.1.1 Initialization Sequence 179
 - 10.1.2 Shutdown Sequence 179
 - 10.1.3 Traversing the ACPI Namespace (Low Level) 179
 - 10.1.4 Traversing the ACPI Namespace (High Level) 182
 - 10.2 Implementing the OS Services Layer..... 183
 - 10.2.1 Parameter Validation..... 183
 - 10.2.2 Memory Management 183
 - 10.2.3 Scheduling Services..... 183
 - 10.2.4 Mutual Exclusion and Synchronization 183
 - 10.2.5 Interrupt Handling..... 184
 - 10.2.6 Stream I/O 184
 - 10.2.7 Hardware Abstraction (I/O, Memory, PCI Configuration)..... 184

Figures

Figure 1. The ACPI Component Architecture.....	13
Figure 2. ACPI Subsystem Architecture.....	15
Figure 3. Interaction between the Architectural Components	16
Figure 4. Internal Modules of the ACPI Core Subsystem	17
Figure 5. Operating System to ACPI Subsystem Request Flow.....	21
Figure 6. ACPI Subsystem to Operating System Request Flow.....	22
Figure 7. Internal Namespace Structure	25
Figure 8. Global Lock Architecture.....	41
Figure 9. ACPI Debugger Architecture.....	165

Tables

Table 1. C Library Functions Used within the Subsystem	45
Table 2. ACPI Object Type Codes	50
Table 3. ACPI Table Type Codes.....	52
Table 4. Exception Code Values.....	56

1 Introduction

1.1 Document Structure

This document consists of ten major sections:

1. ***Introduction***: Contains a brief overview of the ACPI Component Architecture (CA) and the interfaces for both the Core Subsystem and OS Services Layers.
2. ***Design Overview***: Summary of the computational and architectural model that is implemented by the ACPI component architecture.
3. ***Design and Implementation Details***: Details concerning design decisions and implementation specifics.
4. ***Interface Parameters and Data Types***: Descriptions of the major data types and data structures that are exposed via the external interfaces. Other related information required to use the ACPI subsystems and interfaces.
5. ***Subsystem Configuration***: Description of the available configuration options to tailor the subsystem to different compilers and machines, as well as run-time tuning options.
6. ***ACPI CA Core Subsystem Interfaces***: Detailed description of the programmatic interfaces that are implemented by the core component of the ACPI Component Architecture.
7. ***OS Services Layer Interfaces***: Detailed description of the programmatic interfaces that must be implemented by operating system vendors in the layer that interfaces the ACPI CA Core Subsystem to the host operating system.
8. ***ACPI Debugger***: Overview, installation and configuration, and detailed descriptions of the command set
9. ***Tools and Utilities***: A brief overview of the miscellaneous tools and utilities that are part of the Core Subsystem package.
10. ***Subsystem User Guide***: Tips and techniques on how to use the Core Subsystem interfaces, and how to implement the OSL interfaces to host a new operating system.

1.2 Rationale and Justification

The complexity of the ACPI specification leads to a lengthy and difficult implementation in operating system software. The purpose of the ACPI component architecture is to simplify ACPI implementations for operating system vendors (OSVs) by providing major portions of an ACPI implementation in OS-independent ACPI modules that can be integrated into any operating system.

The ACPI CA software can be hosted on any operating system by writing a small and relatively simple translation service between the ACPI subsystem and the host operating system (This service is known as the OS Services Layer).

1.3 Reference Documents

- *Advanced Configuration and Power Interface Specification*, Revision 1.0b, February 8, 1999
- *Advanced Configuration and Power Interface Specification*, Revision 2.0, July 27, 2000
- *Advanced Configuration and Power Interface Specification*, Revision 2.0a, March 32, 2002
- *Advanced Configuration and Power Interface Specification*, Revision 2.0b, October 11, 2002

1.4 Overview of the ACPI Component Architecture

The ACPI Component Architecture (also referred to by the term “ACPI CA” in this document) defines and implements a group of software components that together create an implementation of the ACPI specification. A major goal of the architecture is to isolate all operating system dependencies to a relatively small translation or conversion layer (the OS Services Layer) so that the bulk of the ACPI CA code is independent of any individual operating system. Therefore, hosting the ACPI CA code on new operating systems requires no source within the CA code itself. The components of the architecture include (from the “top” down):

- A user interface to the power management and configuration features.
- A power management and power policy component (OSPM).
- A configuration management component.
- ACPI-related device drivers (for example, drivers for the Embedded Controller, SMBus, Smart Battery, and Control Method Battery).
- An ACPI Core Subsystem component that provides the fundamental ACPI services (such as the AML interpreter and namespace management).
- An OS Services Layer for each host operating system.

This document describes the ACPI Subsystem portion of the architecture only. Other components of the Component Architecture are described in related documents.

Figure 1. The ACPI Component Architecture

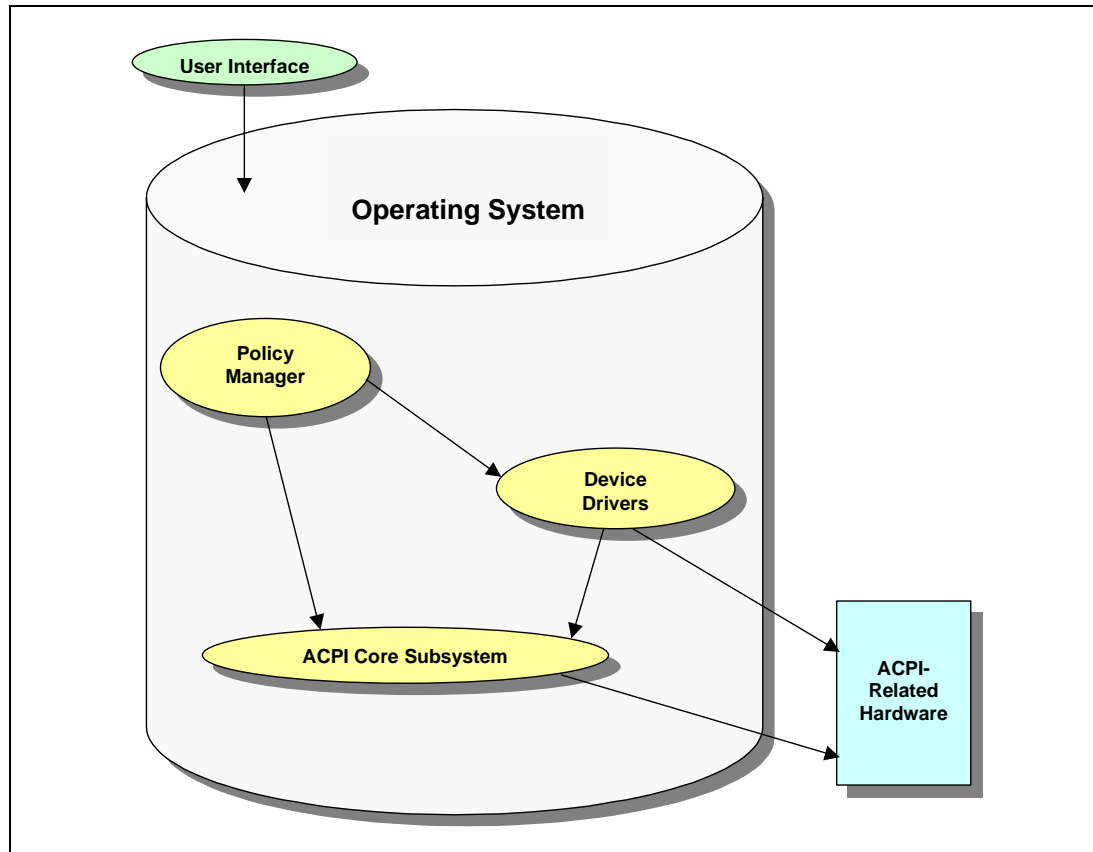

1.5 Overview of the ACPI Core Subsystem

The ACPI Subsystem implements the low level or fundamental aspects of the ACPI specification. Included are an AML parser/interpreter, ACPI namespace management, ACPI table and device support, and event handling. Since the ACPI CA core provides low-level system services, it also requires low-level operating system services such as memory management, synchronization, scheduling, and I/O. To allow the Core Subsystem to easily interface to any operating system that provides such services, an *Operating System Services Layer* translates OS requests into the system calls provided by the host operating system. The OS Services Layer is the only component of the ACPI CA that contains code that is specific to a host operating system. Thus, the ACPI Subsystem consists of two major software components:

1. The ACPI Core Subsystem provides the fundamental ACPI services that are independent of any particular operating system.
2. The OS Services Layer (OSL) provides the conversion layer that interfaces the ACPI Core Subsystem to a particular host operating system.

When combined into a single static or loadable software module such as a device driver or kernel subsystem, these two major components form the *ACPI Subsystem*. Throughout this document, the term “ACPI Subsystem” refers to the combination of the ACPI Core Subsystem with the OS Services Layer components into a single module, driver, or load unit.

1.5.1 ACPI Core Subsystem

The ACPI Core Subsystem supplies the major building blocks or subcomponents that are required for all ACPI implementations — including an AML interpreter, a namespace manager, ACPI event and resource management, and ACPI hardware support.

One of the goals of the Core Subsystem is to provide an abstraction level high enough such that the OSL does not need to understand or know about the very low-level ACPI details. For example, all AML code is hidden from the OSL and host operating system. Also, the details of the ACPI hardware are abstracted to higher-level software interfaces.

The Core Subsystem implementation makes no assumptions about the host operating system or environment. The only way it can request operating system services is via interfaces provided by the *OS Services Layer*.

The primary user of the services provided by the ACPI Core Subsystem is the OS Services Layer, since it is the OS Services Layer that provides an external interface appropriate for the host operating system. For example, the ACPI subsystem may be packaged as a device driver and the OSL then provides the external OS-defined device driver interfaces that the rest of the OS uses to communicate to the ACPI subsystem.

1.5.2 Operating System Services Layer

The OS Services Layer (or *OSL*) operates as a bi-directional translation service for both requests from the host OS to the ACPI subsystem, and from the ACPI subsystem to the host OS. These two functions are independent of each other in many ways. In one direction, the OSL translates host OS requests from the native format into one or more calls to the ACPI Core Subsystem. In the other direction, the OSL implements a generic set of OS service interfaces by using the primitives available from the host OS.

Because of its nature, the OS Services Layer must be implemented anew for each supported host operating system. There is a single ACPI Core Subsystem, but there must be an OS Services Layer for each operating system supported by the ACPI component architecture.

The primary function of the OSL in the ACPI Component Architecture is to be the small glue layer that binds the much larger Core Subsystem to the host operating system. Because of the nature of ACPI itself — such as the requirement for an AML interpreter and management of a large namespace data structure — most of the implementation of the specification is independent of any operating system services. Therefore, the Core Subsystem is the larger of the two components.

The overall ACPI Component Architecture in relation to the host operating system is diagrammed below.

Figure 2. ACPI Subsystem Architecture

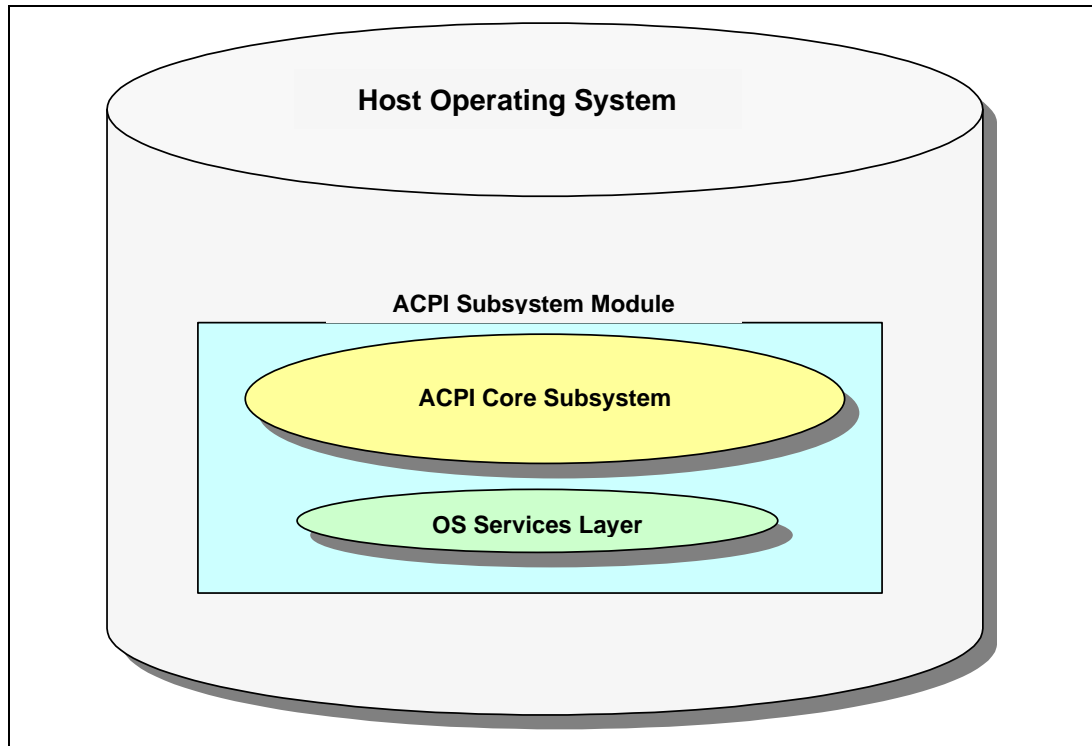

1.5.3 Relationships Between the Host OS, Core Subsystem, and OSL

1.5.3.1 Host Operating System Interaction

The Host Operating System makes requests to the ACPI subsystem using the interfaces that are defined between the OSL component and the Host OS. The host typically does *not* make calls directly to the Core Subsystem component because the **Acpi*** interfaces are typically too low-level for the host. Also, the direct call interface to the Core Subsystem is probably not appropriate for the host-to-OSL interface — a device driver interface is far more likely to be used instead. In this sense, the OSL component acts as a “wrapper” for the Core Subsystem component.

The OSL component “calls up” to the host operating system whenever operating system services are required, either for the OSL itself, or on behalf of the Core Subsystem component. All native calls directly to the host are confined to the OS Services Layer, for obvious reasons.

1.5.3.2 OS Services Layer Interaction

The OS Services Layer implements two types of interfaces, one for each of two distinct callers:

- The Host OS interface is the only external (public) interface from the host OS into the ACPI subsystem. The mechanism used to implement this interface can be whatever is appropriate for the host OS — such as a device driver or internal subsystem interface. The OSL-host OS interface receives ACPI requests from the operating system and translates them into one or more requests to the Core Subsystem component. Therefore, the OSL calls the Core Subsystem to implement the host OS interface.

- The **AcpiOs*** interfaces provide common operating system services to the Core Subsystem such as memory allocation, mutual exclusion, hardware access, and I/O. The Core Subsystem component uses these interface to gain access to OS services in an OS-independent manner. Therefore, the OSL component makes calls to the host operating system to implement the **AcpiOs*** interface.

1.5.3.3 ACPI Core Subsystem Interaction

The *ACPI Core Subsystem* implements a single type of interface:

- The **Acpi*** interfaces provide the actual ACPI services. When operating system services are required during the servicing of an ACPI request, the Core Subsystem makes requests to the host OS indirectly via the fixed **AcpiOs*** interfaces.

The diagram below illustrates the relationships and interaction between the various architectural elements by showing the flow of control between them. Note that the host never calls the Core Subsystem directly — it accesses services that are provided by the OSL. Also, the Core Subsystem never calls the host directly — instead it makes calls to the **AcpiOs*** interfaces in the OSL. It is this level of indirection in both directions that allows the Core Subsystem to be truly operating system independent.

Figure 3. Interaction between the Architectural Components

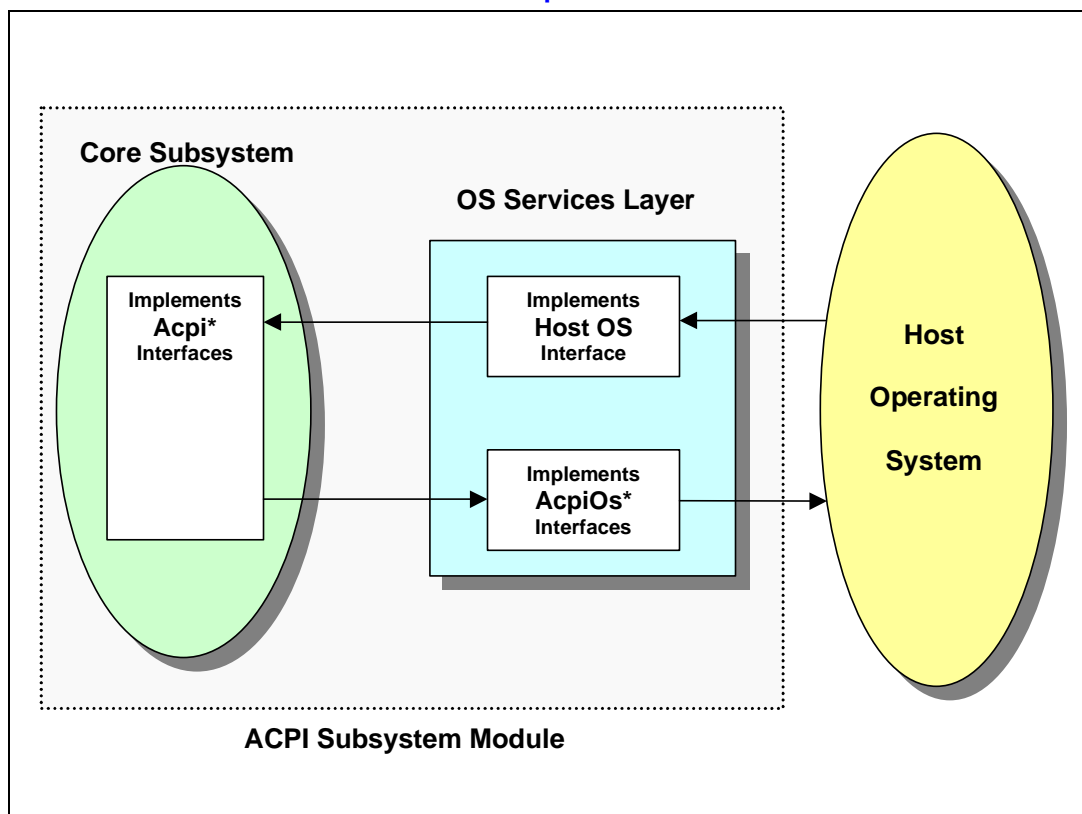

1.6 Architecture of the ACPI Core Subsystem

The Core Subsystem is divided into several logical modules or sub-components. Each module implements a service or group of related services. This section describes each sub-component and identifies the classes of external interfaces to the components, the mapping of these classes to the individual components, and the interface names.

These ACPI modules are the OS-independent parts of an ACPI implementation that can share common code across all operating systems. These modules are delivered in source code form (the language used is ANSI C), and can be compiled and integrated into an OS-specific ACPI driver or subsystem (or whatever packaging is appropriate for the host OS.)

The diagram below shows the various internal modules of the ACPI Core Subsystem and their relationship to each other. The AML interpreter forms the foundation of the component, with additional services built upon this foundation.

Figure 4. Internal Modules of the ACPI Core Subsystem

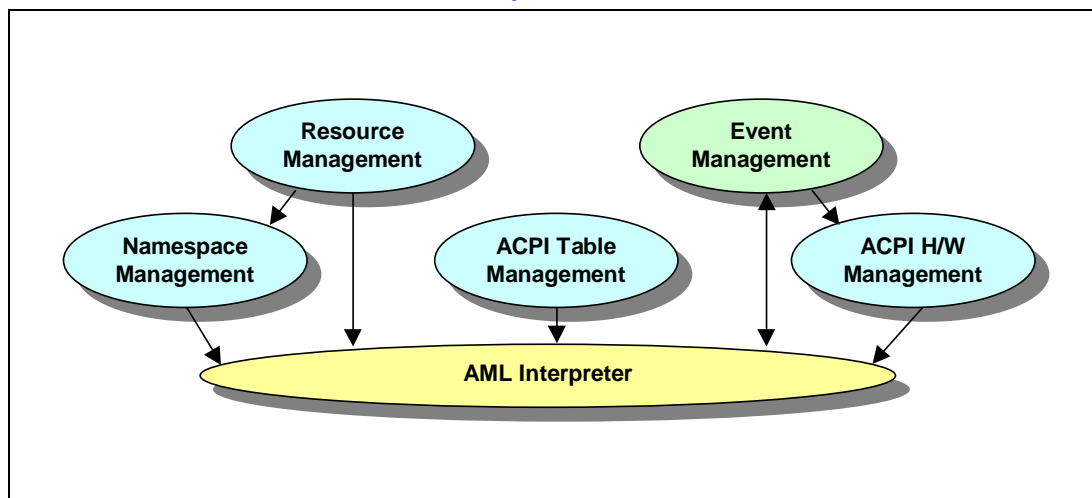

1.6.1 AML Interpreter

The AML interpreter is responsible for the parsing and execution of the AML byte code that is provided by the computer system vendor. Most of the other services are built upon the AML interpreter. Therefore, there are no direct external interfaces to the interpreter. The services that the interpreter provides to the other services include:

- AML Control Method Execution
- Evaluation of Namespace Objects

1.6.2 ACPI Table Management

This component manages the ACPI tables such as the RSDT, FADT, FACS, DSDT, etc. The tables may be loaded from the firmware or directly from a buffer provided by the host operating system. Services include:

- ACPI Table Parsing
- ACPI Table Verification

- ACPI Table installation and removal

1.6.3 Namespace Management

The Namespace component provides ACPI namespace services on top of the AML interpreter. It builds and manages the internal ACPI namespace. Services include:

- Namespace Initialization from either the BIOS or a file
- Device Enumeration
- Namespace Access
- Access to ACPI data and tables

1.6.4 Resource Management

The Resource component provides resource query and configuration services on top of the Namespace manager and AML interpreter. Services include:

- Getting and Setting Current Resources
- Getting Possible Resources
- Getting IRQ Routing Tables
- Getting Power Dependencies

1.6.5 ACPI Hardware Management

The hardware manager controls access to the ACPI registers, timers, and other ACPI-related hardware. Services include:

- ACPI Status register and Enable register access
- ACPI Register access (generic read and write)
- Power Management Timer access
- Legacy Mode support
- Global Lock support
- Sleep Transitions support (S-states)
- Processor Power State support (C-states)
- Other hardware integration: Throttling, Processor Performance, etc.

1.6.6 Event Handling

The Event Handling component manages the ACPI System Control Interrupt (SCI). The single SCI multiplexes the ACPI timer, Fixed Events, and General Purpose Events (GPEs). This component also manages dispatch of notification and Address Space/Operation Region events. Services include:

- ACPI mode enable/disable
- ACPI event enable/disable

- Fixed Event Handlers (Installation, removal, and dispatch)
- General Purpose Event (GPE) Handlers (Installation , removal, and dispatch)
- Notify Handlers (Installation, removal, and dispatch)
- Address Space and Operation Region Handlers (Installation, removal, and dispatch)

1.7 Architecture of the OS Services Layer (OSL)

The OS Services Layer component of the architecture enables the rehosting or retargeting of the other components to execute under different operating systems, or to even execute in environments where there is no host operating system. In other words, the OSL component provides the glue that joins the other components to a particular operating system and/or environment. The OSL implements interfaces and services using the system calls and utilities that are available from the host OS. Therefore, an OS Services Layer must be written for each target operating system.

The OS Services Layer has several roles.

1. It acts as the front-end for OS-to-ACPI requests. It translates OS requests that are received in the native OS format (such as a system call interface, an I/O request/result segment interface, or a device driver interface) into calls to Core Subsystem interfaces.
2. It exposes a set of OS-specific application interfaces. These interfaces translate application requests to calls to the ACPI interfaces
3. The OSL component implements a standard set of interfaces that perform OS dependent functions (such as memory allocation and hardware access) on behalf of the Core Subsystem component. These interfaces are themselves *OS-independent* because they are constant across all OSL implementations. It is the *implementations* of these interfaces that are OS-dependent, because they must use the native services and interfaces of the host operating system.

1.7.1 Functional Service Groups

The services provided by the OS Services Layer can be categorized into several distinct groups, mostly based upon *when* each of the services in the group are required. There will be boot time functions, device load time functions, run time functions, and asynchronous functions.

The OS Services Layer exposes these services to the software above it via interfaces that can be used by the host operating system, device drivers, and applications. These interfaces are not defined by this document because they are highly dependent on the host OS. For example, if the OSL and ACPI Core Subsystems are bundled together to form an ACPI device driver, the interfaces to the driver may be in the form of IOCTL requests or some other form of I/O request block. On the other hand, if the ACPI subsystem is integrated into the host operating system as a standard OS subsystem, the interfaces to the OS Services Layer may take the form of a more conventional system call interface, or even simply a local procedure call interface.

Although it is the OS Services Layer that exposes these services to the rest of the operating system, it is very important to note that the OS Services Layer makes use of the services of the lower-level ACPI Core Subsystem to implement its services. It is the intent of the component architecture that the Core Subsystem is a service that is private to the OSL — that is, that only the OSL makes calls to the Core Subsystem.

1.7.1.1 OS Bootload-Time Services

Boot services are those functions that must be executed very early in the OS load process, before most of the rest of the OS initializes. These services include the ACPI subsystem initialization, ACPI hardware initialization, and execution of the _INI control methods for various devices within the ACPI namespace.

1.7.1.2 Device Driver Load-Time Services

For the devices that appear in the ACPI namespace, the operating system must have a mechanism to detect them and load device drivers for them. The Device driver load services provide this mechanism. The ACPI subsystem provides services to assist with device and bus enumeration, resource detection, and setting device resources.

1.7.1.3 OS Run-Time Services

The runtime services include most if not all of the external interfaces to the ACPI subsystem. These services also include event logging and power management functions.

1.7.1.4 Asynchronous Services

The asynchronous functions include interrupt servicing (System Control Interrupt), Event handling and dispatch (Fixed events, General Purpose Events, Notification events, and Operation Region access events), and error handling.

1.7.2 Required Functionality

There are three basic functions of the OS Services Layer:

1. Manage the initialization of the entire ACPI subsystem, including both the OSL and ACPI Core Subsystems.
2. Translate requests for ACPI services from the host operating system (and its applications) into calls to the Core Subsystem component. This is not necessarily a one-to-one mapping. Very often, a single operating system request may be translated into many calls into the ACPI Core Subsystem.
3. Implement an interface layer that the Core Subsystem component uses to obtain operating system services. These standard interfaces (defined in this document as the **AcpiOs*** interfaces) include functions such as memory management and thread scheduling, and must be implemented using the available services of the host operating system.

This section discusses the services and interfaces that the OS Services Layer is required to provide. Only the external definition of these interfaces is clearly defined by this document. The actual implementation of the services and interfaces is OS dependent and may be very different for different operating systems.

1.7.2.1 Requests from OS to ACPI Subsystem

OS to ACPI requests are by their nature very dependent upon the structure of the operating system. For example, the data format the OS requires to maintain resources will vary greatly from OS to OS. One of the roles of the OS Services Layer is to translate native operating system ACPI requests into calls to the ACPI Core Subsystem. For example, the OS Services Layer must translate the ACPI resource structure to the native OS resource structure.

The exact ACPI services required (and the requests made to those services) will vary from OS to OS. However, it can be expected that most OS requests will fit into the broad categories of the functional service groups described earlier: boot time functions, device load time functions, and runtime functions.

The flow of OS to ACPI requests is shown in the diagram below.

Figure 5. Operating System to ACPI Subsystem Request Flow

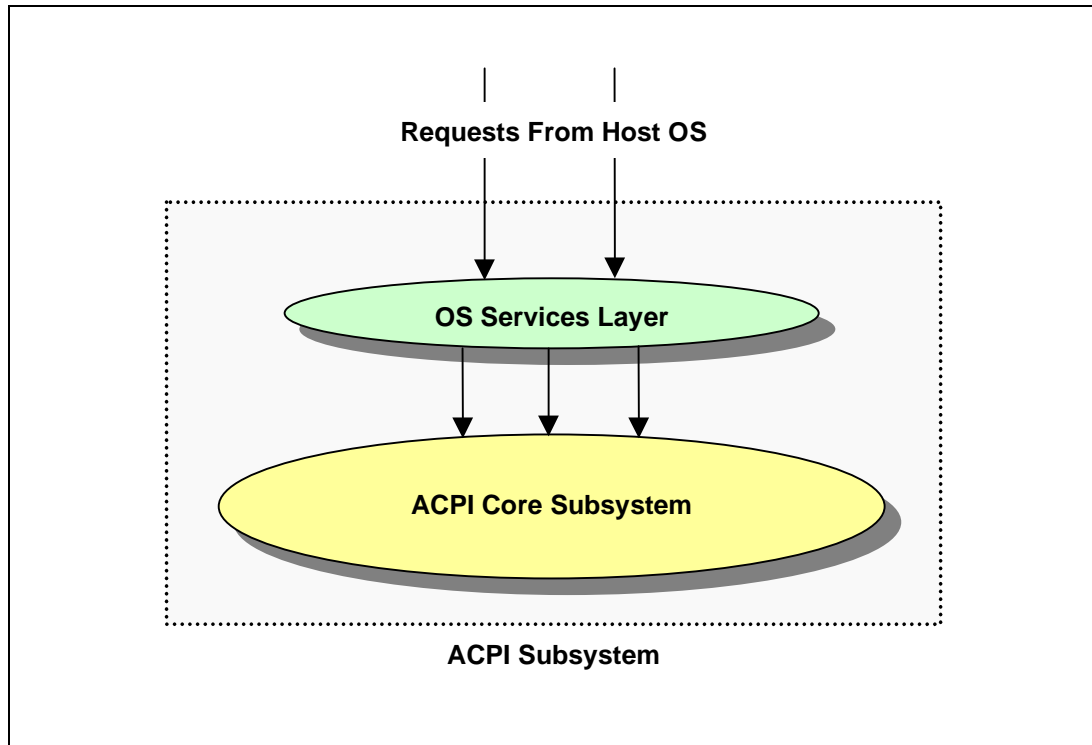

1.7.2.2 Requests from Application to ACPI Subsystem

Application level interfaces should be provided in the OS Services Layer to enable the creation of user interfaces for configuration and management of the ACPI system by either the OS vendor or third party software vendors.

The application interfaces must include sufficient functionality that an application will be able to present to the user a clear picture of the ACPI namespace including the interdependencies for enumeration, power, and data.

The type and style of these application interfaces is completely dependent on the architecture of the host operating system and where the ACPI subsystem fits into that architecture. The interfaces may be device driver style interfaces, or system calls into an operating system layer.

1.7.2.3 Requests from ACPI Subsystem to OS

ACPI to OS requests are requests for OS services made by the ACPI subsystem. These requests must be serviced (and therefore implemented) in a manner that is appropriate to the host operating system. These requests include calls for OS dependent functions such as I/O, resource allocation, error logging, and user interaction. The ACPI Component Architecture defines interfaces to the OS

Services Layer for this purpose. These interfaces are constant (i.e. they are *OS-independent*), but they must be implemented uniquely for each target OS.

The flow of ACPI to OS requests is shown in the diagram below.

Figure 6. ACPI Subsystem to Operating System Request Flow

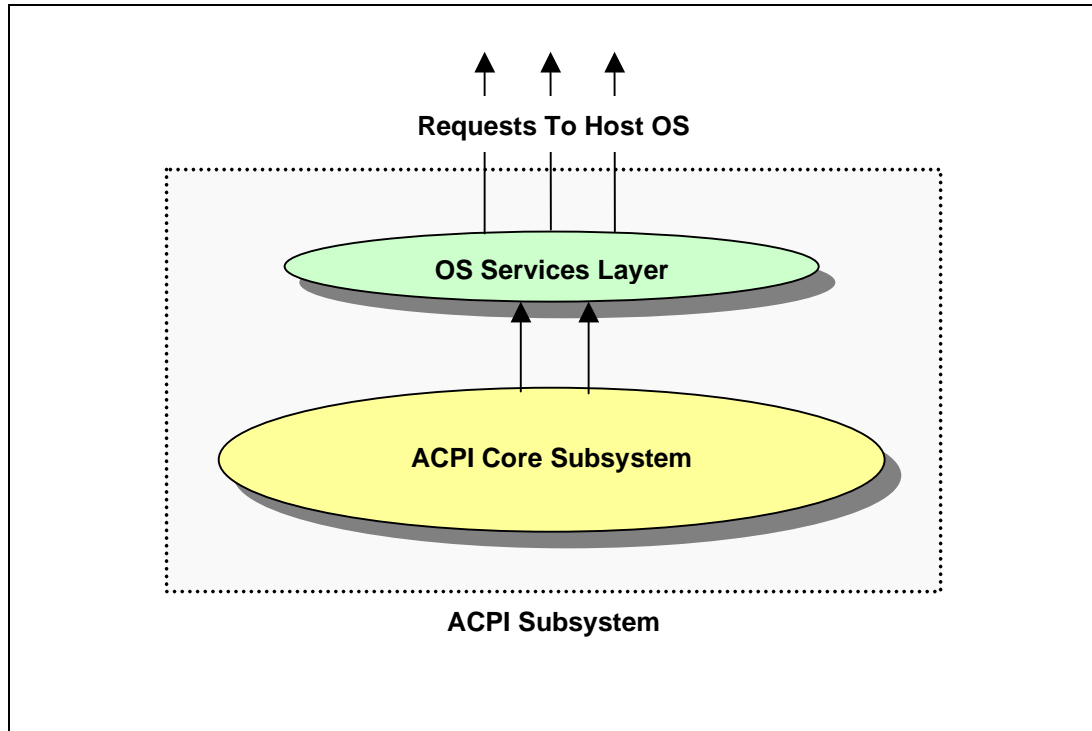

2 Design Overview

This section contains information about concepts, data types, and data structures that are common to both the Core Subsystem and OSL components of the ACPI Subsystem.

2.1 ACPI Namespace Fundamentals

The *ACPI Namespace* is a large data structure that is constructed and maintained by the Core Subsystem component. Constructed primarily from the AML defined within an ACPI Differentiated System Description Table (DSDT), the namespace contains a hierarchy of named ACPI objects.

2.1.1 Named Objects

Each object in the namespace has a fixed 4-character name (32-bits) associated with it. The *root object* is referenced by the backslash as the first character in a pathname. Pathnames are constructed by concatenating multiple 4-character object names with a period as the name separator.

2.1.2 Scopes

The concept of an object *scope* relates directly to the original source ASL that describes and defines an object. An object's scope is defined as all objects that appear between the pair of open and close brackets immediately after the object. In other words, the scope of an object is the container for all of the *children* of that object.

In some of the ACPI CA interfaces, it is convenient to define a scope parameter that is meant to represent this container. For example, when converting an ACPI name into an object handle, the two parameters required to resolve the name are the *name* itself, and a containing *scope* where the name can be found. When the object that matches the name is found within the scope, a handle to that object can be returned.

Example Scopes, Names, and Objects:

In the ASL code below, the scope of the object `_GPE` contains the objects `_L08` and `_L0A`.

```
Scope (\_GPE)
{
    Method (_L08)
    {
        Notify (\_SB.PCI0.DOCK, 1)
    }
    Method (_L0A)
    {
        Store (0, \_SB.PCI0.ISA.EC0.DCS)
    }
}
```

In this example, there are three ACPI namespace *objects*, about which we can observe the following:

- The *names* of the three objects are `_GPE`, `_L08`, and `_L0A`.
- The *child objects* of parent object `_GPE` are `_L08` and `_L0A`.
- The *absolute pathname* (or *fully qualified pathname*) of object `_L08` is “`_GPE._L08`”.

- The *scope* of object `_GPE` contains both the `_L08` and `_L0A` objects.
- The objects `_L08` and `_L0A` have no *scope* associated with them in the internal namespace since they do not define any child objects.
- The *containing scope* of object `_L08` is the scope owned by the object `_GPE`.
- The *parent* of both objects `_L08` and `_L0A` is object `_GPE`.
- The *type* of both objects `_L08` and `_L0A` is `ACPI_TYPE_METHOD`.
- The *next object* after object `_L08` is object `_L0A`. In the example `_GPE` scope, there are no additional objects after object `_L0A`.
- Since `_GPE` is a namespace object at the root level (as indicated by the preceding backslash in the name), its parent is the *root object*, and its containing scope is the *root scope*.

2.1.3 Predefined Objects

During initialization of the internal namespace within Core Subsystem component, there are several predefined objects that are always created and installed in the namespace, regardless of whether they appear in any of the loaded ACPI tables. These objects and their associated types are shown below.

```

"_GPE",    ACPI_TYPE_ANY    // General Purpose Event block
"_PR_",    ACPI_TYPE_ANY    // Processor block
"_SB_",    ACPI_TYPE_ANY    // System Bus block
"_SI_",    ACPI_TYPE_ANY    // System Indicators block
"_TZ_",    ACPI_TYPE_ANY    // Thermal Zone block
"_REV",    ACPI_TYPE_NUMBER // Revision
"_OS_",    ACPI_TYPE_STRING // OS Name
"_GL_",    ACPI_TYPE_MUTEX  // Global Lock

```

2.1.4 Logical Namespace Layout

The diagram below shows the logical namespace after the predefined objects and the `_GPE` scope has been entered.

Figure 7. Internal Namespace Structure

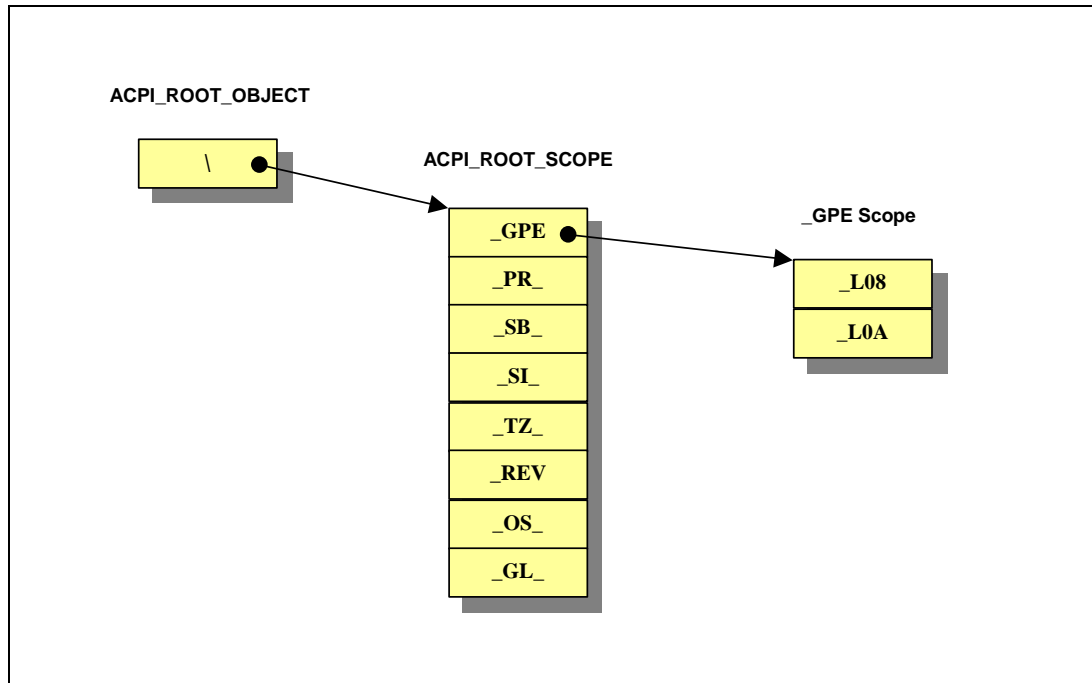

2.2 Execution Model

2.2.1 Initialization

The initialization of the ACPI Core Subsystem must be driven entirely by the OS Services Layer. Since it may be appropriate (depending on the requirements of the host OS) to initialize different parts of the Core Subsystem at different times, the Core Subsystem initialization is a multi-step process that must be coordinated by the OSL. The four main steps are outlined below.

1. Perform a global initialization of the Core Subsystem – this initializes the global data and other items within the Core Subsystem.
2. Load the ACPI tables – The FACS, FADT, DSDT, etc. must be copied (or mapped) into the Core Subsystem before the internal namespace can be constructed. The tables may be loaded from the firmware, loaded from an input buffer, or some combination of both. The minimum set of ACPI tables includes an FACS, an FADT, and a DSDT.
3. Build the internal namespace – this causes the Core Subsystem to parse the DSDT and build an internal namespace from the objects found therein.
4. Enable ACPI mode of the machine. Before ACPI events can occur, the machine must be put into ACPI mode. The Core Subsystem installs an interrupt handler for the System Control Interrupts (SCIs), and transitions the hardware from legacy mode to ACPI mode.

2.2.2 Memory Allocation

There are two models of memory allocation that can be used. In the first model, the caller to the ACPI subsystem pre-allocates any required memory. This allows maximum flexibility for the caller

since only the caller knows what is the appropriate memory pool to allocate from, whether to statically or dynamically allocate the memory, etc. In the second model, the caller can choose to have the ACPI subsystem allocate memory via the `AcpiOsAllocate` interface. Although this model is less flexible, it is far easier to use and is sufficient for most environments.

Each memory allocation model is described below.

2.2.2.1 Caller Allocates All Buffers

In this model, the caller preallocates buffers of a large enough size and posts them to the ACPI subsystem via the `ACPI_BUFFER` data type.

It is often the case that the required buffer size is not known by even the ACPI subsystem until after the evaluation of an object or the execution of a control method has been completed. Therefore, the “get size” model of a separate interface to obtain the required buffer size is insufficient. Instead, a model that allows the caller to pre-post a buffer of a large enough size has been chosen. This model is described below.

For ACPI interfaces that use the `ACPI_BUFFER` data type as an output parameter, the following protocol can be used to determine the exact buffer size required:

1. Set the buffer length field of the `ACPI_BUFFER` structure to zero, or to the size of a local buffer that is thought to be large enough for the data.
2. Call the `Acpi` interface.
3. If the return exception code is `AE_BUFFER_OVERFLOW`, the buffer length field has been set by the interface to the buffer length that is actually required.
4. Allocate a buffer of this length and initialize the length and buffer pointer field of the `ACPI_BUFFER` structure.
5. Call the `Acpi` interface again with this valid buffer of the required length.

Alternately, if the caller has some idea of the buffer size required, a buffer can be posted in the original call. If this call fails, only then is a larger buffer allocated. See Section 4.2.6 - “`ACPI_BUFFER` – Input and Output Memory Buffers” for additional discussion on using the `ACPI_BUFFER` data type.

2.2.2.2 ACPI Allocates Return Buffers

In this model, the caller lets the ACPI subsystem allocate return buffers. It is the responsibility of the caller to delete these returned buffers.

For the ACPI interfaces that use the `ACPI_BUFFER` data type as an output parameter, the following protocol is used to allow the ACPI subsystem to allocate return buffers:

1. Set the buffer length field of the `ACPI_BUFFER` structure `ACPI_ALLOCATE_BUFFER`.
2. Call the `Acpi` interface.
3. If the return exception code is `AE_OK`, the interface completed successfully and a buffer was allocated. The length of the buffer is contained in the `ACPI_BUFFER` structure.
4. Delete the buffer by calling `AcpiOsFree` with the pointer contained in the `ACPI_BUFFER` structure.

2.2.3 Parameter Validation

Only limited parameter validation is performed on all input parameters passed to the ACPI Core Subsystem. All calls to the Core Subsystem code should come from the OSL portion, not directly from user or application code. Therefore, the OSL code is a trusted portion of the kernel code, and should perform all limit and range checks on buffer pointers, strings, and other input parameters before passing them down to the Core Subsystem code.

The limited parameter validation consists of sanity checking input parameters for non-zero values and nothing more. Any additional parameter validation (such as buffer length validation) must occur in the OSL component.

2.2.4 Exception Handling

All exceptions that occur during the processing of a request to the ACPI Core Subsystem are translated into the appropriate ACPI_STATUS return code and bubbled up to the original caller.

All exception handling is performed inline by the caller to the Core Subsystem interfaces. There are no exception handlers associated with either the **Acpi*** or **AcpiOs*** calls.

2.2.5 Multitasking and Reentrancy

All components of the ACPI subsystem are intended to be fully reentrant and support multiple threads of execution. To achieve this, there are several mutual exclusion OSL interfaces that must be properly implemented with the native host OS primitives to ensure that mutual exclusion and synchronization can be performed correctly. Although dependent on the correct implementation of these interfaces, the ACPI Core Subsystem is otherwise fully reentrant and supports multiple threads throughout the component, with the exception of the AML interpreter, as explained below.

Because of the constraints of the ACPI specification, there is a major limitation on the concurrency that can be achieved within the AML interpreter portion of the subsystem. The specification states that at most one control method can be actually executing AML code at any given time. If a control method blocks (an event that can occur only under a few limited conditions), another method may begin execution. However, it can be said that the specification precludes the concurrent execution of control methods. Therefore, the AML interpreter itself is essentially a single-threaded component of the ACPI subsystem. Serialization of both internal and external requests for execution of control methods is performed and managed by the front-end of the interpreter.

2.2.6 Event Handling

The term *Event Handling* is used somewhat loosely to describe the class of asynchronous events that can occur during the execution of the ACPI subsystem. These events include:

- System Control Interrupts (SCIs) that are generated by both the ACPI Fixed and General Purpose Events.
- Notify events that are generated via the execution of the ASL *Notify* keyword in a control method.
- Events that are caused by accesses to an address space or operation region during the execution of a control method.

Each of these events and the support for them in the ACPI subsystem are described in more detail below.

2.2.6.1 Fixed Events

Incoming Fixed Events can be handled by the default ACPI subsystem event handlers, or individual handlers can be installed for each event. Only device drivers or system services should install such handlers.

2.2.6.2 General Purpose Events

Incoming General Purpose Events (GPEs) are usually handled by executing a control method that is associated with a particular GPE. According to the ACPI specification, each GPE level may have a method associated with it whose name is of the form `_Txx`, where **T** is the type of GPE — either **E** for edge-triggered or **L** for level triggered. **xx** is the GPE level in hexadecimal (See the ACPI specification for complete details.) This control method is never executed in the context of the SCI interrupt handler, but is instead queued for later execution by the host operating system.

In addition to this mechanism, individual handlers for GPE levels may be installed. It is not required that a handler be installed for a GPE level, and in fact, currently the only device that requires a dedicated GPE handler is the ACPI Embedded Controller. A device driver for the Embedded Controller would install a handler for the GPE that is dedicated to the EC.

If a GPE handler is installed for a given GPE, the handler is invoked first, then the associated control method (if any) is queued for execution.

GPE Block Devices are also supported. These GPE blocks may be installed and removed dynamically as necessary. The Core Subsystem provides centralized GPE handling and dispatch, and provides the necessary interfaces to install and remove GPE Block Devices.

2.2.6.3 Notify Events

An ACPI Notify Event occurs as a result of the execution of a *Notify* opcode during the execution of a control method. A notify event occurs on a particular ACPI object, and this object must be a device or thermal zone. If a handler is installed for notifications on a particular device, this handler is invoked during the execution of the *Notify* opcode, in the context of the thread that is executing the control method.

Notify handlers should be installed by device drivers and other system services that know about the particular device or thermal zone on which notifications will be received.

2.2.7 Address Spaces and Operation Regions

ASL source code and the corresponding AML code use the *Address Space* mechanism to access data that is out of the direct scope of the ASL. For example, Address Spaces are used to access the CMOS RAM and the ACPI Embedded Controller. There are several pre-defined Address Spaces that may be accessed and user-defined Address Spaces are allowed.

The Operating System software (which includes the AML Interpreter) allows access to the various address spaces via the ASL *Operation Region* (OpRegion) construct. An OpRegion is a named window into an address space. During the creation of an OpRegion, the ASL programmer defines both the boundaries (window size) and the address space to be accessed by the OpRegion. Specific addresses within the access window can then be defined as named *fields* to simplify their use.

The AML Interpreter is responsible for translating ASL/AML references to named *Fields* into accesses to the appropriate Address Space. The interpreter resolves locations within an address space using the fields' address within an OpRegion and then the OpRegion's offset within the address space. The resolved address, address access width, and function (read or write) are then passed to the address space handler who is responsible for performing the actual physical access of the address space.

2.2.7.1 Installation of Address Space Handlers

At runtime, the ASL/AML code cannot access an address space until a handler has been installed for that address space. An ACPI CA user can either install the default address space handlers or install user defined address space handlers using the *AcpiInstallAddressSpaceHandler* interface.

Each Address Space is “owned” by a particular device such that all references to that address space within the *scope* of the device will be handled by that device's address space handler. This mechanism allows multiple address space/operation region handlers to be installed for the same *type* of address space, each mutually exclusive by virtue of being governed by the ACPI address space scoping rules. For example, picture a platform with two SMBus devices, one an embedded controller based SMBus; the other a PCI based SMBus. Each SMBus must expose its own address space to the ASL without disrupting the function of the other. In this case, there may be two device drivers and two distinctly different address space handlers, one for each type of SMBus. This mechanism can be employed in a similar manner for the other predefined address spaces. For example, the PCI Configuration space for each PCI bus is unique to that bus. Creation of a region within the scope of a PCI bus must refer only to that bus.

Address space handlers must be installed on a named object in the ACPI namespace or on the special object ACPI_ROOT_OBJECT. This is required to maintain the scoping rules of address space access. Address handlers are installed for the namespace object representing the device that “owns” that address space. Per ASL rules, regions that access that address space must be declared in the ASL within the scope of that namespace object.

It is the responsibility of the ACPI CA user to enumerate the namespace and install address handlers as needed.

2.2.7.2 ACPI-Defined Address Spaces

The ACPI 2.0b specification defines address spaces for:

- System Memory
- System I/O
- PCI Configuration Space
- System Management Bus (SMBus)
- Embedded Controller
- CMOS
- PCI Bar Target

The ACPI CA subsystem implements default address space handlers for the following ACPI defined address spaces:

- System Memory
- System I/O
- PCI Configuration Space

Default address space handlers can be installed by supplying the special value `ACPI_DEFAULT_HANDLER` as the handler address when calling the `AcpiInstallAddressSpaceHandler` interface.

The other predefined address spaces (Embedded Controller and SMBus) have no default handlers and will not be accessible without OS provided handlers. This is typically the role of the Embedded Controller and SMBus device drivers.

2.3 Policies and Philosophies

This section provides insight into the policies and philosophies that were used during the design and implementation of the ACPI CA Core Subsystem. Many of these policies are a direct interpretation of the ACPI specification. Others are a direct or indirect result of policies and procedures dictated by the ACPI specification. Still others are simply standards that have been agreed upon during the design of the subsystem.

2.3.1 External Interfaces

2.3.1.1 Exception Codes

All external interfaces (Acpi*) return an exception code as the function return. Any other return values are returned via pointer(s) passed as parameters. This provides a consistent and simple synchronous exception-handling model.

Since the ACPI CA Core Subsystem is reentrant and supports multiple threads on multiple operating systems, a model where an exception code is stored in the task descriptor (such as the *errno* mechanism) was purposefully avoided to improve portability.

2.3.1.2 Memory Buffers

Memory for return objects, buffers, etc. that is returned via the external interfaces is rarely allocated by the subsystem itself. The model chosen is to force the caller to always pre-allocate memory. This forces the calling software to manage both the creation and deletion of its own buffers — hopefully minimizing memory fragmentation and avoiding memory leaks. The exception to this is the `ACPI_BUFFER` type, where the caller can direct the ACPI subsystem to allocate return buffers.

2.3.2 Subsystem Initialization

2.3.2.1 ACPI Table Validation

All ACPI tables that are examined by the ACPI core subsystem undergo some minimal validation before they are accepted. This includes all tables found in the RSDT regardless of whether the signature is recognized, and all tables loaded from user buffers. The following validations are performed on each table. A warning is issued for tables that do not pass one or more of these tests:

1. The Table pointer must point to valid physical memory
2. The signature (in the table header) must be 4 ASCII chars, *even if the name is not recognized*.
3. The table must be readable for length specified in the header
4. The table checksum must be valid (with the exception of the FACS, which has no checksum).

Other than this validation, tables that are not recognized by their table header signature are simply ignored.

2.3.2.2 Required ACPI Tables

At the very minimum, the ACPI CA Core Subsystem requires the following ACPI tables:

1. One *Fixed ACPI Description Table* (FADT — signature “FACP”). This table contains important configuration information about the ACPI hardware
2. One *Firmware ACPI Control Structure* (FACS). This table contains the OS-to-firmware interface including the firmware waking vector and the Global Lock.
3. One *Differentiated System Description Table* (DSDT). This table contains the primary AML code for the system.

3 Design and Implementation Details

3.1 Required Host OS Initialization Sequence

This section describes a generic operating system initialization sequence that includes the ACPI CA subsystem. The ACPI CA subsystem must be loaded very early in the kernel initialization. In fact, ACPI support must be considered to be one of the fundamental startup modules of the kernel. The basic OS requirements of the ACPI subsystem include memory management, synchronization primitives, and interrupt support. As soon as these services are available, ACPI CA should be initialized. Only after ACPI is available can motherboard device enumeration and configuration begin.

In summary, ACPI Tables are descriptions of the hardware, therefore must be loaded into the OS very early.

3.1.1 Bootload and Low Level Kernel Initialization

- OS is loaded into memory via bootloader or downloader
- Initialize OS data structures, objects and run-time environment
- Initialize low-level kernel subsystems
- Initialize and enable free space manager
- Initialize and enable synchronization primitives
- Initialize basic interrupt mechanism and hardware
- Initialize and start system timer

3.1.2 ACPI CA Subsystem Initialization

- Load ACPI Tables
- Initialize Namespace
- Initialize ACPI Hardware and install SCI interrupt handler
- Initialize ACPI Address Spaces (Default handlers and user handlers)
- Initialize ACPI Objects (`_STA`, `_INI`, `_HID`)
- Find PCI Root Bus(es) and install PCI config space handlers

3.1.3 Other OS Initialization

- Remaining non-ACPI Kernel initialization
- Initialize and start System Resource Manager
- Determine processor configuration

3.1.4 Device Enumeration, Configuration, and Initialization

- Match motherboard devices to drivers via `_HID`

- Initialize PCI subsystem: Obtain _PRT interrupt routing table and Initialize PCI routing. PCI driver enumerates PCI bus and loads appropriate drivers.
- Initialize Embedded Controller support/driver
- Initialize SM Bus support/driver
- Load and initialize drivers for any other motherboard devices

3.1.5 Final OS Initialization

- Load and initialize any remaining device drivers
- Initialize upper layers of the OS
- Activate user interface

3.2 Required ACPI CA Initialization Sequence

This section presents a detailed description of the initialization process for the ACPI CA subsystem. The initialization interfaces are provided at a sufficient granularity to allow customization of the initialization sequence for each host operating system and host environment.

3.2.1 ACPI CA Subsystem Initialization

3.2.1.1 AcpiInitializeSubsystem

This mandatory step must be first. It initializes the ACPI CA Subsystem software, including all global variables, tables, and data structures. All elements of the ACPI CA Subsystem are initialized, including the OSL interface layer and the OSPM layer. The interface provided is *AcpiInitializeSubsystem*.

3.2.2 ACPI Table and Namespace Initialization

This required phase loads the ACPI tables from the BIOS or elsewhere and initializes the internal ACPI namespace.

3.2.2.1 AcpiLoadFirmwareTables

This interface finds and loads all ACPI tables that are presented to the system by the resident firmware. This is the normal interface used to obtain the ACPI tables on an ACPI-supported platform.

3.2.2.2 AcpiLoadTable

This interface is used to directly load ACPI tables from somewhere (anywhere) other than the BIOS. The table is transferred to the ACPI subsystem via a memory buffer. The *AcpiExec* utility uses this interface to load ACPI tables from a file.

3.2.2.3 Internal ACPI Namespace Initialization

As the various ACPI tables are loaded (installed into the internal data structures of the CA subsystem), the internal ACPI Namespace (database of named ACPI objects) is constructed from those tables. As each table is loaded, the following tasks are automatically performed:

- First pass parse – Load all named ACPI objects into the internal namespace
- Second pass parse – Resolve all forward references within the ACPI table
- First pass parse of all control methods – Sanity check to ensure that the tables can be completely parsed, including the control methods. The resulting parse tree is not stored, since control methods are parsed on the fly every time they are executed. (This task represents minimal CPU overhead, and saves huge amounts of memory that would be consumed by storing parse trees.)
- Lock the namespace so that GPEs will not cause control methods to run

3.2.3 Handler Installation

Once the namespace has been constructed, the OS should install any handlers that it may require during execution of the ACPI CA subsystem. The purpose of installing these handlers at this point in the initialization process is so that the handlers are in place before execution of any control methods is allowed – thereby insuring that any custom handlers will not miss any of the events that they are intended to handle. Any handlers installed in this phase will override the default handlers.

3.2.3.1 Handler Types

The following handler installation interfaces are available

AcpiInstallAddressSpaceHandler

This function is used to install address space handlers to override the default address space handlers (for the predefined address spaces) or install handlers for custom address spaces.

AcpiInstallFixedEventHandler

This function is used to install handlers for ACPI Fixed Events.

AcpiInstallGpeHandler

This function is used to install handlers for ACPI General Purpose Events (GPEs).

AcpiInstallNotifyHandler

This function is used to install handlers for ACPI device notifications.

3.2.4 Subsystem Initialization Completion

3.2.4.1 AcpiEnableSubsystem

This single interface performs the functions described in the sections below. To summarize the actions performed by this call:

- Initialize ACPI hardware and ACPI events

- Enter ACPI Mode
- Initialize ACPI device objects
- Install handlers for the PCI Root Bridge(s)
- Initialize all Operation Regions (Address Spaces) and Fields

3.2.4.2 ACPI Hardware and Event Initialization

This step sets up the ACPI hardware, initializes the ACPI Event handling, and puts the system into ACPI mode if necessary. This step is optional when running in “hardware-independent” mode – when there is no access to hardware by the ACPI subsystem (For example, the *AcpiDump* and *AcpiExec* utilities run in this mode.)

The ACPI hardware must be initialized and an SCI interrupt handler must be installed before it is architecturally safe to evaluate ACPI objects and execute control methods, for the following reasons:

1. Any ACPI named object (predefined or otherwise) can be implemented as a control method and there is no way to safely make any assumptions about which objects are and are not implemented as control methods. This is dependent on the individual AML on each platform.
2. Because control methods can access the ACPI hardware, cause SCIs, and most interesting of all, *can block while waiting for an SCI to be serviced*, it is inherently unsafe and architecturally incorrect to attempt to execute control methods without first initializing the hardware and installing an SCI interrupt handler

This step is only optional when running in “hardware-independent” mode. Otherwise it is required to setup the ACPI hardware and System Control Interrupt handling. ACPI mode is entered if the machine is in legacy mode. IF the machine is already in ACPI mode (such as an IA-64 machine), no action is required.

- Initialize the ACPI hardware
- Initialize the SCI, GPE, and FixedEvent handling
- Enter ACPI mode

After this step, control methods can be executed because the hardware is now initialized and the subsystem is able to take ACPI-related interrupts (*System Control Interrupts or SCIs*). The execution of any control method (including the **_REG** methods) can cause the generation of an SCI – therefore, the hardware must be initialized before control methods may be run. Additional ACPI subsystem initialization that requires control method execution can now be completed.

3.2.4.3 Just-in-time Address Space Initialization

This phase includes just-in-time initialization for any Operation Regions, Packages, Buffers, or Fields that are accessed by the control methods executed here. For example, if a **_REG** method for a PCIConfig address space accesses a SystemMemory Operation Region, the definition of that particular SystemMemory region is fully evaluated at that time. (Operation Regions and CreateField ASL statements can contain executable AML code and therefore the initialization of the objects must be deferred until the CA subsystem and ACPI hardware are both initialized).

Therefore, Address Spaces are initialized *in the order in which they are accessed*, not in the order that they are declared in the ASL source code.

When any Address Space is initialized, the associated **_REG** method (if any) is executed as well.

3.2.4.4 AcpiInitializeObjects

3.2.4.4.1 ACPI Device Initialization

This step initializes device objects found within the ACPI namespace. The PCI configuration space handlers are setup in this phase. **Note:** The initialization of the device objects entails running the **_INI** method on all devices that are present as indicated by the **_STA** method. This is *not* an actual initialization of the device hardware – this is left to the actual device drivers for the hardware.

The **_STA**, **_INI**, and **_HID** methods are run on all ACPI objects of type *Device* found within the namespace (that are ready and available.)

Traverse the entire namespace and run these methods on each and every device found within: **_STA**, **_INI**, **_HID** (in this order.) Any operation regions accessed by these methods will be automatically initialized by the just-in-time address space initialization mechanism.

If the **_HID** method indicates the presence of a PCI Root Bridge (if it returns an HID value of PNP0A03), perform PCI Configuration Space initialization on the bridge. Install the PCI address space handler on the bridge (and on all descendents) and run the **_ADR**, **_SEG**, and **_BBN** methods to obtain the PCI device, function and bus numbers. Then run the associated **_REG** method to indicate the availability of the region.

Note that this sequence of events (run the **_STA**, **_INI**, and **_HID** methods on all devices) is the correct (and the only proper) method to detect the presence of the PCI root bridge or bridges.

3.2.4.4.2 Other ACPI Object Initialization

This step initializes the remaining AML Operation Regions and Fields that were not initialized during the device and address space initialization.

Operation Regions and CreateField ASL statements can contain executable AML code and therefore the initialization of the objects must be deferred until the CA subsystem and ACPI hardware are both initialized. Some of this initialization may have been completed during the earlier steps. This step completes that initialization.

This final pass through the loaded ACPI tables will execute all AML code outside of the control methods that has not already been executed on-demand during the previous phases. The purpose is to initialize the Field and OpRegion objects by executing all CreateField, OperationRegion code in the AML. ACPI 2.0 has additional elements that will need to be initialized this way (*Not yet implemented.*)

3.2.4.5 Other Operating System ACPI-related Initialization

All external ACPI interfaces are available.

- Enumerate devices using the **_HID** method
- Load, configure, and install device drivers
- Device Drivers install handlers for other address spaces such as SmBus, EC, and custom address spaces
- The PCI driver enumerates PCI devices and loads PCIConfig handlers for PCI-to-PCI-bridge devices (which causes the associated child PCI bus_REG methods to run, etc. RON's comment).

3.2.5 System Shutdown

3.2.5.1 AcpiTerminate

This step frees all dynamically allocated resources back to the host operating system. The subsystem may be restarted at Phase One after this step completes.

3.3 Multithreading Support

3.3.1 Reentrancy

All external interfaces to the ACPI CA Core Subsystem are fully reentrant. There are limitations to the amount of concurrency allowed during control method execution, but these limitations are transparent to the calling threads — in the sense that threads that attempt to execute control methods will block until the interpreter becomes available.

3.3.2 Control Method Execution

Most of the multithread support within the ACPI subsystem is implemented using traditional locks and mutexes around critical (shared) data areas. However, the AML interpreter design is different in that the ACPI specification defines a special threading behavior for the execution of control methods. The design implements the following portion of the ACPI specification that defines a partially multithreaded AML interpreter in four sentences:

A control method can use other internal, or well-defined, control methods to accomplish the task at hand, which can include defined control methods provided by the operating software. Interpretation of a Control Method is not preemptive, but can block. When a control method does block, the operating software can initiate or continue the execution of a different control method. A control method can only assume that access to global objects is exclusive for any period the control method does not block.

3.3.2.1 Control Method Blocking

First of all, how can a control method block? This is a fairly exhaustive list of the possibilities:

1. Executes the **Sleep()** ASL opcode
2. Executes the **Acquire()** ASL opcode and the request cannot be immediately satisfied
3. Executes the **Wait()** ASL opcode and the request cannot be immediately satisfied
4. Attempts to acquire the **Global Lock** (via Operation Region access, etc), but must wait
5. Attempts to execute a control method that is serialized and already executing (or is blocked), or has reached its concurrency limit
6. Invokes the host debugger via a write to the debug object or executes the **BreakPoint()** ASL opcode
7. Accesses an **Operation Region** which results in a dispatch to a user-installed handler that blocks on I/O or other long-term operation
8. A **Notify** AML opcode results in a dispatch to a user-installed handler that blocks in a similar way

3.3.2.2 Control Method Execution Rules

Here are some Control Method execution “rules” that the ACPI CA multithread support is built upon. These rules are not always stated explicitly in the ACPI specification — some of them are inferred.

1. A Control Method will run to completion (as far as the interpreter is concerned - this doesn't include thread preemption and interrupt handling by the OS) unless it blocks (i.e. a control method will not be arbitrarily preempted *by the interpreter.*)
2. If a Control Method blocks, the next Control Method in the queue will be executed. When the original (blocked) control method becomes ready, it will **not** preempt the executing method. Instead, it will be placed back on the execution queue (*We could place the method at the tail or the head of the execution queue, or leave this decision to the OSL implementers*).
3. Methods can be *serialized* (non-reentrant) or reentrant. A thread will block if an attempt is made to execute (either via direct invocation or indirectly via a method call) a serialized method that is already executing (or is blocked).
4. The “implicit” synchronization supported by Operation Regions and mentioned in the ACPI specification seems to depend entirely on the non-preemptive control method execution model (see above.)

3.3.2.3 A Simple Multithreading Model

The actual mechanisms to block a thread are simple and are already in place on the OSL side:

1. **Sleep ()** - directly implemented via *AcpiOsSleep ()*, will block the caller and free the processor.
2. **Acquire ()** - implemented via an **AcpiOsSemaphore**.
3. **Wait ()** - implemented via an **AcpiOsSemaphore**.
4. **Global Lock** - implemented via an **AcpiOsSemaphore** and the interrupt caused by the release of the lock.
5. Concurrency limit - we could put a queue at each method (high overhead), or simply re-queue the thread (perhaps in a high-priority queue if we implement one).
6. Host Debugger - These are simply **AcpiOs*** calls that we assume will block for a long time.
7. Operation Region Handler blocks on some OS primitive
8. Notify handler blocks in the same manner as (7).

These mechanisms are sufficient to implement the blocking, but this isn't enough to implement the execution semantics of “no preemption unless the method does something to block itself”. This requires additional support. I will take a stab at a multithread model here; please feel free to modify or comment.

1. True concurrent control method execution is not allowed. Although the interpreter is “reentrant” in the sense that more than one thread can call into the interpreter, only one thread at any given time (system wide) can be **actively** interpreting a control method. All other control methods (and the threads that are executing them) must be either blocked or awaiting execution/resumption.
2. Therefore, we can put a mutex around the entire interpreter and only allow a thread access to the interpreter when there are no other accessing threads.

3. The implication and result is that when an executing control method blocks, it is defined to have stopped accessing the interpreter, and is no longer executing within the interpreter.
4. If any interrupt handler needs interpreter services (such as the EC driver and the **_Qxx** control methods), it must schedule a thread for execution. When it runs, this thread calls the interpreter to execute the method.

The algorithm below implements the model described above:

```

AmlExecuteControlMethod ()
  Acquire (Global Interpreter Lock)
  If <the method does anything that might block>
    Check if it will block (such as wait on a semaphore with a zero
    timeout, or grab global lock)
  If <we know or the method will block or still think that it might
  block>
    (such as sleep, acquire-no-units, wait-no-event, global lock not
    available, reached concurrency limit) - and perhaps before we
    dispatch to a user OpRegion or Notify handler)
    Release (Global Interpreter Lock)      (Allow another thread to
    execute a method)
    Execute the blocking call (AcpiOsSleep or AcpiOsWaitSemaphore)
    Acquire (Global Interpreter Lock)      (Must re-enter the
    interpreter, can't preempt running thread!)
  Release (Global Interpreter Lock)      (Finished with this method, free
  the interpreter)
  
```

3.3.2.4 A More Complex Multithreading Model

This extension to the model shown above adds a mechanism to implement a “priority” system where all executing and blocked Control Methods have a higher priority than methods that are queued and have never executed yet. This allows the interpreter some control over the scheduling of threads that are executing control methods, without relying directly on an OS-defined priority mechanism. In other words, it provides an OS-dependent way to schedule threads the way we want.

Two semaphores are used, call them an “Outer Gate” and an “Inner Gate”. A thread must pass through both gates before it can begin execution. Once inside both gates, it releases the outer gate, allowing a thread in to wait at the inner gate. When the first thread completes execution of the method, it releases the inner gate, allowing the next thread to proceed. If at any time during execution a thread must block, it releases the inner gate, blocks, then re-acquires the inner gate when it resumes execution.

The maximum length of the queue at the inner gate will never exceed **<the number of blocked threads (running a method)> + 1** (the last thread allowed in through the outer gate).

In the typical (blocking) case, T1 blocks allowing T2 to run. T1 unblocks and eventually waits on the inner gate. T2 eventually completes and signals the inner gate. T1 now runs to completion. All of this happens regardless of the number of threads waiting at the outer gate - therefore, it gives priority to threads that are already running a method.

The algorithm below implements the modified model described above:

```

AmlExecuteControlMethod ()
  Acquire (Outer Lock)
  Acquire (Inner Lock) (Must acquire both locks to begin execution)
  Release (Outer Lock) (Allow one thread into the outer lock)
  If <the method does anything that might block>
    Check if it will block (such as wait on a semaphore with a zero
    timeout)
  
```

```

If <we know or the method will block or still think that it might
block>
(such as sleep, acquire-no-units, wait-no-event, global lock not
available, reached concurrency limit) - and perhaps before we
dispatch to a user OpRegion or Notify handler)
  Release (Inner Lock)      (Allow another thread to begin
  execution of a method)
  Execute the blocking call (AcpiOsSleep, AcpiOsWaitSemaphore,
  etc.)
  Acquire (Inner Lock)      (Must re-enter the interpreter since
  we cannot preempt running thread!)
  Release (Inner Lock)      (Finished with this method, free the
  interpreter)

```

Note: It is not so important that the threads free the locks in **reverse** order as it is that they all unlock the locks **in the same order**. Since they are all executing the same code, this behavior is ensured.

While the simple multithreading model will be *sufficient*, the more complex model allows a more “fair” allocation of resources under heavy load. The outstanding question is whether there will ever be enough concurrent use of the AML interpreter to justify the complexity of the second model.

3.3.3 Global Lock Support

The ACPI *Global Lock* is intended to be a mutual exclusion mechanism that allows both the host operating system and the resident firmware to access common hardware and data structures. It is not intended to be a mutual exclusion mechanism between threads implemented by the host OS.

The one and **only** purpose of the Global Lock is to provide synchronization between the resident firmware (SMI BIOS, etc.) and all other software on the platform.

The following assumptions are made about interaction between the OS and firmware concerning the ACPI Global Lock:

- When the firmware owns the global lock, the OS queues up all requests to acquire the global lock
- When the firmware releases the global lock, the OS grabs it and releases (satisfies) all queued requests
- When the last thread calls the OS to release the global lock (now all of the **acquires** have performed a matching **release**), the OS does the actual hardware release.

With this algorithm, it is possible to “starve” the firmware for arbitrary lengths of time, but this is not considered to be a major problem.

The diagram below shows the global lock in relation to the BIOS and other system software.

Figure 8. Global Lock Architecture

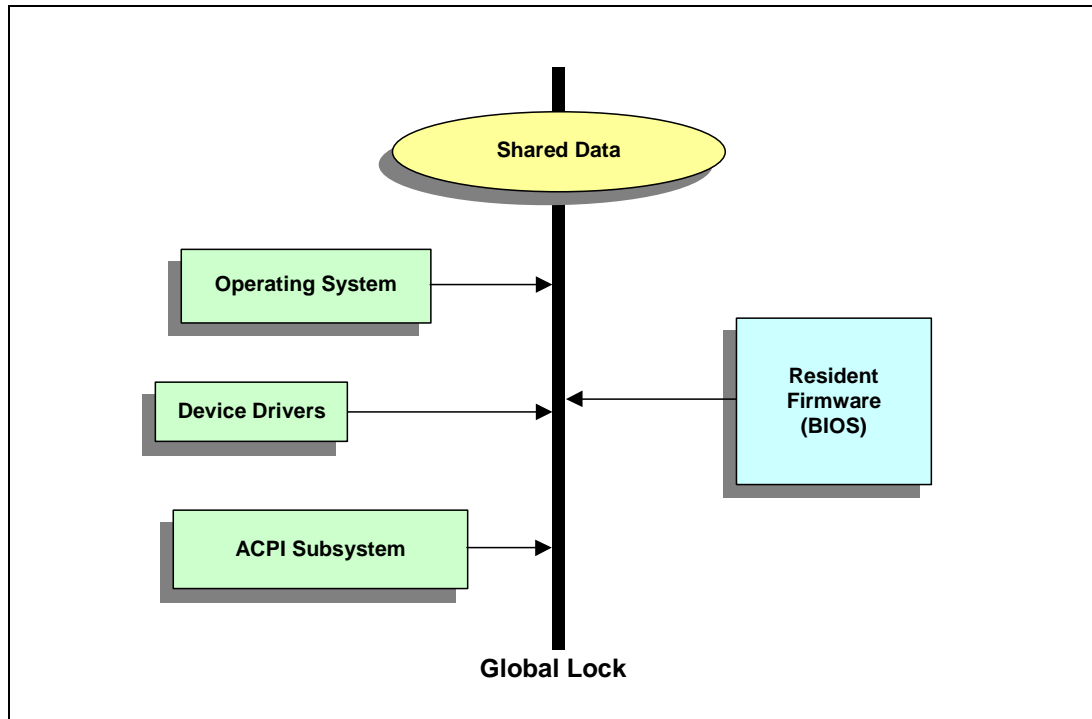

3.3.3.1 Obtaining The Global Lock

```
Gbl_GlobalLockThreadCount++;
If (Gbl_WeHaveTheGlobalLock)
{
    return; /* All done! */
}
If (AcquireHardwareGlobalLock())
{
    Gbl_WeHaveTheGlobalLock = TRUE;
    return; /* All done! */
}
AmlExitInterpreter ();
AcpiOsWaitSemaphore (GlobalLockSemaphore, WAIT_FOREVER);
AmlEnterInterpreter ();
```

3.3.3.2 Releasing the Global Lock

```
Gbl_GlobalLockThreadCount--;
If (Gbl_GlobalLockThreadCount == 0)
{
    Gbl_WeHaveTheGlobalLock = FALSE;
    ReleaseHardwareGlobalLock ();
}
```

3.3.3.3 Global Lock Interrupt Handler

```

/* We get an SCI when the firmware releases the lock */

AcquireHardwareGlobalLock ( )
Gbl_WehaveTheGlobalLock = TRUE;
For <all threads waiting on the lock> (Gbl_GlobalLockThreadCount)
{
    AcpIoSignalSemaphore (GlobalLockSemaphore);
}

```

3.3.4 Single Thread Environments

Both the design and implementation of the ACPI CA Core Subsystem is targeted primarily for inclusion within the kernel of a multitasking operating system. However, it is possible to generate and operate the subsystem within a single threaded environment — with either a primitive operating system or loader, or even standalone with no additional system software other than a few device drivers.

The successful operation of the ACPI CA in any environment depends upon the correct implementation of the OSL layer underneath it. This requirement is no different for a single threaded environment, but some special considerations must be made:

The primary mechanism used for mutual exclusion and multithread synchronization throughout the ACPI subsystem is the OSL *Semaphore*. Since this mechanism is not required in a single threaded environment, it is sufficient to implement these interfaces to simply always return an AE_OK exception code.

When used within an OS kernel at ring 0, the ACPI debugger requires a dedicated thread to perform command line processing. Since this mechanism is not required in a single threaded environment, it can be configured out during generation of the subsystem.

If defined, the “ACPI_APPLICATION” switch disables all multithread support throughout the ACPI core subsystem.

3.4 Debugging Support

Two styles of debugging are supported with the debugging tools available with the ACPI Subsystem:

1. Extraordinary amounts of trace and debug output can be generated from debug output and trace statements that are embedded in the debug version of the ACPI subsystem. This data can be used to track down problems after the fact. So much data can be generated that the debug output can be selectively enabled on a per-subcomponent basis and even a finer granularity of the type of debug statement can be selected.
2. An AML debugger is provided that has the ability to single step control methods to examine the results of individual AML opcodes, and to change the values of local variables and method arguments if necessary.

3.4.1 Function Tracing (ACPI_FUNCTION_TRACE Macro)

Most of the functions within the subsystem use the ACPI_FUNCTION_TRACE macro upon entry and the return_ACPI_STATUS macro upon exit. For the debug version of the subsystem, if the

function trace debug level is enabled, the `ACPI_FUNCTION_TRACE` macro displays the name of the module and function and the current call nesting level. Upon exit, the `return ACPI_STATUS` macro again displays the name of the function, the call nesting level, and the return status code of the call.

The next few lines show examples of the function tracing. On each invocation of the `ACPI_FUNCTION_TRACE` macro, we see the module name and line number, followed by the call nesting level (2 digits), followed by the name of the actual procedure entered. Some versions of the `ACPI_FUNCTION_TRACE` macro allow one of the function parameters to be displayed as well.

```

Executing \BITZ
nsobject-0356 [07] NsGetAttachedObject      : ----Entry 004A2CC8
nsobject-0373 [07] NsGetAttachedObject      : ----Exit- 004A2728
dswscope-0186 [07] DsScopeStackPush         : ----Entry
  utalloc-0235 [07] UtAcquireFromCache       : 004A1DC8 from State Cache
  utmisc-0711 [08] UtPushGenericState       : ----Entry
  utmisc-0719 [08] UtPushGenericState       : ----Exit-
dswscope-0223 [07] DsScopeStackPush         : ----Exit- AE_OK
dsmthdat-0274 [07] DsMethodDataInitArgs     : ----Entry 004A1438
dsmthdat-0655 [08] DsStoreObjectToLocal     : ----Entry
dsmthdat-0657 [08] DsStoreObjectToLocal     : Opcode=104 Idx=0 Obj=004A2F08
  
```

The function entry and exit macros have the ability to generate huge amounts of output data. However, this is often the best way to determine the actual execution path taken by subsystem. If the problem being debugged can be narrowed to a single control method, tracing can be enabled for that method only, thus reducing the amount of debug data generated.

3.4.2 Execution Debug Output (`ACPI_DEBUG_PRINT` Macro)

The `ACPI_DEBUG_PRINT` macro is used throughout the source code of the ACPI core subsystem to selectively print debug messages. Over 900 invocations of the `ACPI_DEBUG_PRINT` are scattered throughout the ACPI subsystem source. This macro is compiled out entirely for non-debug versions of the subsystem.

Output from `ACPI_DEBUG_PRINT` can be enabled at two levels: on a per-subcomponent level (Namespace manager, Parser, Interpreter, etc.), and on a per-type level (informational, warnings, errors, and more.) There are two global variables that set these output levels:

1. **DebugLayer** Bit field that enables/disables debug output from entire subcomponents within the ACPI subsystem.
2. **DebugLevel** Bit field that enables/disables the various debug output levels

The example below shows some of the debug output from a namespace search. None of the output of the function tracing is shown here, but the enter/exit traces would appear interspersed with the other debug output.

```

nsutils-0346: NsInternalizedName: returning [00821F30] (abs) "\BITZ"
nsaccess-0424: NsLookup: Searching from root [007F09B4]
nsaccess-0477: NsLookup: Multi Name (1 Segments, Flags=0)
nsaccess-0494: NsLookup: [BITZ/]
nssearch-0166: NsSearchOnly: Searching \/ [007F09B4]
nssearch-0168: NsSearchOnly: For BITZ (type 0)
nssearch-0239: NsSearchOnly: Name BITZ (actual type 8) found at 007FC384
nseval-0302: NsEvaluateByName: \BITZ [007FC384] Value 007FE0C0
  
```

3.4.3 ACPI Debugger

Provided as a subcomponent of the ACPI Core Subsystem, the ACPI/AML Debugger provides the capability to display subsystem data structures and objects (such as the namespace and associated internal object), and to debug the execution of control methods (including single step and breakpoint support.) By using only two OSL interfaces, *AcpiOsGetLine* for input and *AcpiOsPrint* for output, the debugger can operate standalone or as an extension to a host debugger.

The debugger provides a more active debugging environment where data can be examined and altered during the execution of control methods.

3.5 Environmental Support Requirements

This section describes the environmental requirements of the ACPI subsystem. This includes the external functions and header files that the subsystem uses, as well as the resources that are consumed from the host operating system.

3.5.1 Resource Requirements

Static Memory:

Non-Debug Version:	73.7K Code,	9.5K Data,	83.2K Total
Debug Version:	156.1K Code,	63.6K Data,	219.7K Total

Dynamic Memory: TBD: (Tables, namespace, objects)

System Objects: TBD: (Semaphores)

3.5.2 C Library Functions

In order to make the ACPI Core Subsystem as portable and truly OS-independent as possible, there is only extremely limited use of standard C library functions within the Core Subsystem component itself. The calls are limited to those that can generate code in-line or link to small, independent code modules. Below is a comprehensive list of the C library functions that are used by the Core Subsystem code.

Table 1. C Library Functions Used within the Subsystem

sprintf
memcpy
memset
strcat
strcmp
strcpy
strlen
strncmp
strncat
strncpy
strstr
strtoul
strupr
toupper
tolower
va_list
va_start
va_end

If “SYSTEM_CLIB_FUNCTIONS” is defined during the compilation of the subsystem, the subsystem must be linked to a local C library to resolve these Clib references. If SYSTEM_CLIB_FUNCTIONS is not set, the subsystem will automatically link to local implementations of these functions. Note that the local implementations are written in portable ANSI C, and may not be as efficient as local assembly code implementations of the same functions. Therefore, it is recommended that the local versions of the C library functions be used if at all possible.

3.5.3 System Include Files

The following include files (header files) are useful for users of both the **Acpi*** and **AcpiOs*** interfaces:

- `acexcep.h` The ACPI_STATUS exception codes
- `acpiosxf.h` The prototypes for all of the **AcpiOs*** interfaces
- `acpixf.h` The prototypes for all of the **Acpi*** interfaces
- `actypes.h` Common data types used across all interfaces

3.5.3.1 Customization to the Target Environment

The use of header files that are external to the ACPI subsystem is confined to a single header file named *acenv.h*. These external include files consist of several of the standard C library headers:

- `stdio.h`
- `stdlib.h`
- `stdarg.h`

- `string.h`

When generating the Core Subsystem component from source, the `acenv.h` header may be modified if the filenames above are not appropriate for generation on the target system. For example, some environments use a different set of header files for the kernel-level C library versus the user-level C library. Use of C library routines within the Core Subsystem component has been kept to a minimum in order to enhance portability and to ensure that the Core Subsystem will run as a kernel-level component in most operating systems.

4 Interface Parameters and Data Types

4.1 ACPI Subsystem Interface Parameters

4.1.1 ACPI Names and Pathnames

As defined in the ACPI Specification, all ACPI object *names* (the names for all ACPI objects such as control methods, regions, buffers, packages, etc.) are exactly four ASCII characters long. The ASL compiler automatically pads names out to four characters if an input name in the ASL source is shorter. (The padding character is the underscore.) Since all ACPI names are always of a fixed length, they can be stored in a single 32-bit integer to simplify their use.

Pathnames are null-terminated ASCII strings that reference named objects in the ACPI namespace. A pathname can be composed of multiple 4-character ACPI names separated by a period. In addition, two special characters are defined. The backslash appearing at the start of a pathname indicates to begin the search at the root of the namespace. A carat in the pathname directs the search to traverse upwards in the namespace by one level. The ACPI namespace is defined in the ACPI specification. The ACPI CA subsystem honors all of the naming conventions that are defined in the ACPI specification.

Frequently in this document, pathnames are referred to as “fully qualified pathname” or “absolute pathname” or “relative pathname”. A pathname is fully qualified if it begins with the backslash character (`\`) since it defines the complete path to an object from the root of the namespace. All other pathnames are relative since they specify a path to an object from somewhere in the namespace besides the root.

The ACPI specification defines special search rules for single segment (4-character) or standalone names. These rules are intended to apply to the execution of AML control methods that reference named ACPI objects. The ACPI CA Core Subsystem component implements these rules fully for the execution of control methods. It does not implement the so-called “parent tree” search rules for the external interfaces in order to avoid object reference ambiguities.

4.1.2 Pointers

Many of the interfaces defined here pass pointers as parameters. It is the responsibility of the caller to ensure that all pointers passed to the ACPI CA subsystem are valid and addressable. The interfaces only verify that pointers are non-NULL. If a pointer is any value other than NULL, it will be assumed to be a valid pointer and will be used as such.

4.1.3 Buffers

It is the responsibility of the caller to ensure that all input and output buffers supplied to the Core Subsystem component are at least as long as the length specified in the ACPI_BUFFER structure, readable, and writable in the case of output buffers. The Core Subsystem does not perform addressability checking on buffer pointers, nor does it perform range validity checking on the buffers themselves. In the ACPI Component Architecture, it is the responsibility of the OS Services Layer to validate all buffers passed to it by application code, create aliases if necessary to address

buffers, and ensure that all buffers that it creates locally are valid. In other words, the ACPI Core Subsystem *trusts* the OS Services Layer to validate all buffers.

When the length field of `ACPI_BUFFER` is set to `ACPI_ALLOCATE_BUFFER` before a call that returns data in an output buffer, the core subsystem will allocate a return buffer on behalf of the caller. It is the responsibility of the caller to free this buffer when it is no longer needed.

4.2 ACPI Subsystem Data Types

4.2.1 UINT64 and COMPILER_DEPENDENT_UINT64

Beginning with the ACPI version 2.0 specification, the width of integers within the AML interpreter are defined to be 64 bits on all platforms (both 32- and 64-bit). The implementation of this requirement requires the deployment of 64-bit integers across the entire ACPI Core Subsystem. Since there is (currently) no standard method of defining a 64-bit integer in the C language, the `COMPILER_DEPENDENT_UINT64` macro is used to allow the `UINT64` typedef to be defined by each host compiler. The `UINT64` data type is used at the `Acpi*` interface level for both physical memory addresses and ACPI (interpreter) integers.

4.2.2 ACPI_PHYSICAL_ADDRESS

The width of all *physical* addresses is fixed at 64 bits, regardless of the platform or operating system. Logical addresses (pointers) remain the natural width of the machine (i.e. 32 bit pointers on 32-bit machines, 64-bit pointers on 64-bit machines.) This allows for a full 64 bit address space on 64-bit machines as well as “extended” physical addresses (above 4Gbytes) on 32-bit machines.

4.2.3 ACPI_POINTER

This data type is a union that allows either a physical address or logical pointer to be specified. A flags field defines the pointer type.

4.2.4 ACPI_INTEGER

This is the data type that directly corresponds to the ACPI-defined *Integer* data type. Beginning with ACPI 2.0, the width of this data type is 64 bits on all platforms.

4.2.5 ACPI_STRING – ASCII String

The `ACPI_STRING` data type is a conventional “char*” null-terminated ASCII string. It is used whenever a full ACPI pathname or other variable-length string is required. This data type was defined to strongly differentiate it from the `ACPI_NAME` data type.

4.2.6 ACPI_BUFFER – Input and Output Memory Buffers

Many of the ACPI CA interfaces require buffers to be passed into them and/or buffers to be returned from them. A common structure is used for all input and output buffers across the interfaces. The buffer structure below is used for both input and output buffers. The Core Subsystem component

only allocates memory for return buffers if requested to do so — this allows the caller complete flexibility in where and how memory is allocated. This is especially important in kernel level code.

```
typedef struct
{
    UINT32      Length;          // Length in bytes of the buffer;
    void        *Pointer;       // pointer to buffer
} ACPI_BUFFER;
```

4.2.6.1 Input Buffer

An input buffer is defined to be a buffer that is filled with data by the user (caller) before it is passed in as a parameter to one of the ACPI interfaces. When passing an input buffer to one of the Core Subsystem interfaces, the user creates an ACPI_BUFFER structure and initializes it with a pointer to the actual buffer and the length of the valid data in the buffer. Since the memory for the actual ACPI_BUFFER structure is small, it will typically be dynamically allocated on the CPU stack. For example, a user may allocate a 4K buffer for common storage. The buffer may be reused many times with data of various lengths. Each time the number of bytes of *significant* data contained in the buffer is entered in the Length field of the ACPI_BUFFER structure before an Core Subsystem interface is called.

4.2.6.2 Output Buffer

An output buffer is defined to be a buffer that is filled with data by an ACPI interface before it is returned to the caller. When the ACPI_BUFFER structure is used as an output buffer the caller must always initialize the structure by either

1. Placing a value in the Length field that indicates the maximum size of the buffer that is pointed to by the *Pointer* field. The length is used by the ACPI interface to ensure that there is sufficient user provided space for the return value.
2. Initializing the Length field to ACPI_ALLOCATE_BUFFER to cause the ACPI subsystem to allocate a buffer.

If a buffer that was passed in by the caller is too small, the ACPI interfaces that require output buffers will indicate the failure by returning the error code AE_BUFFER_OVERFLOW. The interfaces will never attempt to put more data into the caller's buffer than is specified by the Length field of the ACPI_BUFFER structure (unless ACPI_ALLOCATE_BUFFER is used). The caller may recover from this failure by examining the Length field of the ACPI_BUFFER structure. The interface will place the *required* length in this field in the event that the buffer was too small.

During normal operation, the ACPI interface will copy data into the buffer. It will indicate to the caller the length of data in the buffer by setting the Length field of the ACPI_BUFFER to the actual number of bytes placed in the buffer.

Therefore, the Length field is both an input and output parameter. On input, it indicates either the size of the buffer or an indication to the ACPI subsystem to allocate a return buffer on behalf of the caller. On output, it either indicates the actual amount of data that was placed in the buffer (if the buffer was large enough), or it indicates the buffer size that is required (if the buffer was too small) and the exception is set to AE_BUFFER_OVERFLOW.

4.2.7 ACPI_HANDLE – Object Handle

References to ACPI objects managed by the Core Subsystem component are made via the ACPI_HANDLE data type. A handle to an object is obtained by creating an attachment to the object

via the *AcpiPathnameToHandle* or *AcpiNameToHandle* primitives. The concept is similar to opening a file and receiving a connection – after the pathname has been resolved to an object handle, no additional internal searching is performed whenever additional operations are needed on the object.

References to object scopes also use the `ACPI_HANDLE` type. This allows objects and scopes to be used interchangeably as parameters to Acpi interfaces. In fact, a scope handle is actually a handle to the *first object* within the scope.

4.2.7.1 Predefined Handles

One predefined handle is provided in order to simplify access to the ACPI namespace:

1. **ACPI_ROOT_OBJECT**: A handle to the root object of the namespace. All objects contained within the root scope are children of the root object.

4.2.8 ACPI_OBJECT_TYPE – Object Type Codes

Each ACPI object that is managed by the ACPI subsystem has a **type** associated with it. The valid ACPI object types are defined as follows:

Table 2. ACPI Object Type Codes

ACPI_TYPE_ANY
ACPI_TYPE_INTEGER
ACPI_TYPE_STRING
ACPI_TYPE_BUFFER
ACPI_TYPE_PACKAGE
ACPI_TYPE_FIELD_UNIT
ACPI_TYPE_DEVICE
ACPI_TYPE_EVENT
ACPI_TYPE_METHOD
ACPI_TYPE_MUTEX
ACPI_TYPE_REGION
ACPI_TYPE_POWER
ACPI_TYPE_PROCESSOR
ACPI_TYPE_THERMAL
ACPI_TYPE_BUFFER_FIELD
ACPI_TYPE_DDB_HANDLE
ACPI_TYPE_DEBUG_OBJECT
ACPI_TYPE_EXTERNAL_MAX

4.2.9 ACPI_OBJECT – Method Parameters and Return Objects

The general purpose `ACPI_OBJECT` is used to pass parameters to control methods, and to receive results from the evaluation of namespace objects. The point of this data structure is to provide a common object that can be used to contain multiple ACPI data types.

When passing parameters to a control method, each parameter is contained in an `ACPI_OBJECT`. All of the parameters are then grouped together in an `ACPI_OBJECT_LIST`.

When receiving a result from the evaluation of a namespace object, an `ACPI_OBJECT` is returned in an `ACPI_BUFFER` structure. This allows variable length objects such as ACPI Packages to be returned in the buffer. The first item in the buffer is always the base `ACPI_OBJECT`.

```
typedef union AcpiObj
{
    ACPI_OBJECT_TYPE    Type;           // Object Type
    struct /* ACPI_TYPE_INTEGER */
    {
        ACPI_OBJECT_TYPE    Type;
        ACPI_INTEGER        Value;      // The 64-bit value
    } Integer;

    struct /* ACPI_TYPE_STRING */
    {
        ACPI_OBJECT_TYPE    Type;
        UINT32              Length;     // Length of string minus null
        NATIVE_CHAR         *Pointer;   // points to the string
    } String;

    struct /* ACPI_TYPE_BUFFER */
    {
        ACPI_OBJECT_TYPE    Type;
        UINT32              Length;     // # of bytes in buffer
        UINT8               *Pointer;   // points to the buffer
    } Buffer;

    struct /* ACPI_TYPE_ANY */
    {
        ACPI_OBJECT_TYPE    Type;
        UINT32              Reserved;
        ACPI_HANDLE         Handle;     // object reference
    } Reference;

    struct /* ACPI_TYPE_PACKAGE */
    {
        ACPI_OBJECT_TYPE    Type;
        UINT32              Count;      // # of elements in package
        union AcpiObj       *Elements; // Pointer to array of objects
    } Package;

    struct /* ACPI_TYPE_PROCESSOR */
    {
        ACPI_OBJECT_TYPE    Type;
        UINT32              ProcId;
        ACPI_IO_ADDRESS     PblkAddress;
        UINT32              PblkLength;
    } Processor;

    struct /* ACPI_TYPE_POWER */
    {
        ACPI_OBJECT_TYPE    Type;
        UINT32              SystemLevel;
        UINT32              ResourceOrder;
    } PowerResource;
} ACPI_OBJECT, *PACPI_OBJECT;
```

4.2.10 ACPI_OBJECT_LIST – List of Objects

This object is used to pass parameters to control methods via the *AcpiEvaluateMethod* interface. The *Count* is the number of ACPI objects pointed to by the *Pointer* field. In other words, the *Pointer* field must point to an array that contains *Count* ACPI objects.

```
typedef struct AcpiObjList
{
    UINT32          Count;
    ACPI_OBJECT     *Pointer;
} ACPI_OBJECT_LIST, *PACPI_OBJECT_LIST;
```

4.2.11 ACPI_EVENT_TYPE – Fixed Event Type Codes

The ACPI fixed events are defined in the ACPI specification. The event codes below are used to install handlers for the individual events.

```
EVENT_PMTIMER           // Power Management Timer rollover
EVENT_NOT_USED          // Reserved
EVENT_GLOBAL            // Global Lock released
EVENT_POWER_BUTTON     // Power Button (pressed)
EVENT_SLEEP_BUTTON     // Sleep Button (pressed)
EVENT_RTC               // Real Time Clock alarm
EVENT_GENERAL          // TBD
ACPI_EVENT_MAX
```

4.2.12 ACPI_TABLE_TYPE – ACPI Table Type Codes

The following ACPI tables are supported by the ACPI CA subsystem. The table type codes below are used to load, unload, or get a copy of the individual tables.

Table 3. ACPI Table Type Codes

TABLE_RSDP	Root System Description Pointer
TABLE_DSDT	Differentiated System Description Table
TABLE_FADT	Fixed ACPI Description Table
TABLE_FACS	Firmware ACPI Control Structure
TABLE_PSDT	Persistent System Description Table
TABLE_RSDT	Root System Description Table
TABLE_SSDT	Secondary System Description Table

4.2.13 ACPI_TABLE_HEADER – Common ACPI Table Header

```
typedef struct /* ACPI common table header */
{
    char          Signature [4];          /* Identifies type of table */
    UINT32        Length;                /* Length of table, in bytes,
                                         * including header */

    UINT8         Revision;              /* Specification minor version # */
    UINT8         Checksum;              /* To make sum of entire table = 0 */
    char          OemId [6];             /* OEM identification */
    char          OemTableId [8];        /* OEM table identification */
    UINT32        OemRevision;           /* OEM revision number */
    char          AslCompilerId [4];     /* ASL compiler vendor ID */
    UINT32        AslCompilerRevision; /* ASL compiler revision number */

} ACPI_TABLE_HEADER;
```

4.2.14 ACPI_STATUS – Interface Exception Return Codes

Each of the external ACPI interfaces return an exception code of type `ACPI_STATUS` as the function return value, as shown in the example below:

```
ACPI_STATUS          Status;  
  
Status = AcpiLoadTables (RsdpPhysicalAddress);  
if (Status != AE_OK)  
{  
    // Exception handling code here  
}
```

4.3 ACPI Resource Data Types

These data types are used by the ACPI CA resource interfaces.

4.3.1 PCI IRQ Routing Tables

The *AcpiGetIrqRoutingTable* interface retrieves the PCI IRQ routing tables. This interface returns the routing table in the `ACPI_BUFFER` provided by the caller. Upon return, the *Length* field of the `ACPI_BUFFER` will indicate the amount of the buffer used to store the PCI IRQ routing tables. If the returned status is `AE_BUFFER_OVERFLOW`, the *Length* indicates the size of the buffer needed to contain the routing table.

The `ACPI_BUFFER` *Pointer* points to a buffer of at least *Length* size. The buffer contains a series of `PCI_ROUTING_TABLE` entries, each of which contains both a *Length* member and a *Data* member. The *Data* member is a `PRT_ENTRY`. The *Length* member specifies the length of the `PRT_ENTRY` and can be used to walk the `PCI_ROUTING_TABLE` entries. By incrementing a buffer walking pointer by *Length* bytes, the pointer will reference each succeeding table element. The final `PCI_ROUTING_TABLE` entry will contain no data and have a *Length* member of zero.

Each `PRT_ENTRY` contains the Address, Pin, Source, and Source Index information as described in Chapter 6 of the ACPI Specification. While all structure members are `UINT32` types, the valid portion of both the *Pin* and *SourceIndex* members are only `UINT8` wide. Although the *Source* member is defined as `UINT8 Source[1]`, it can be de-referenced as a null-terminated string.

```

typedef struct          /* A single IRQ table entry */
{
    UINT32    Address;    /* PCI Address of device */
    UINT32    Pin;        /* PCI Pin (0=INTA, 1=INTB, 2=INTC, 3=INTD # */
    UINT32    SourceIndex; /* Index of resource of allocating device */
    UINT8     Source[1];  /* Device that allocates (0 terminated) */
                    /* this interrupt */
} PRT_ENTRY;

typedef struct          /* IRQ table entry packed in the return buffer */
{
    UINT32    Length;    /* Length of this PRT_ENTRY */
    PRT_ENTRY Data;      /* The PRT Entry data */
} PCI_ROUTING_TABLE;

```

4.3.2 Device Resources

Device resources are returned by indirectly executing the `_CRS` and `_PRS` control methods via the `AcpiGetCurrentResources` and `AcpiGetPossibleResources` interfaces. These device resources are needed to properly execute the `_SRS` control method using the `AcpiSetCurrentResources` interface.

These interfaces require an `ACPI_BUFFER` parameter. If the `Length` member of the `ACPI_BUFFER` is set to zero, the `AcpiGet*` interfaces will return an `ACPI_STATUS` of `AE_BUFFER_OVERFLOW` with `Length` set to the size buffer needed to contain the resource descriptors. If the `Length` member is non-zero and `Pointer` in non-NULL, it is assumed that `Pointer` points to a memory buffer of at least `Length` size. Upon return, the `Length` member will indicate the amount of the buffer used to store the resource descriptors.

4.3.2.1 RESOURCE_TYPE – Resource Data Types

The following resource types are supported by the ACPI CA subsystem. The resource types that follow are used in the resource definitions used in the resource handling interfaces:

`AcpiGetCurrentResources`, `AcpiGetPossibleResources`, and `AcpiSetCurrentResources`.

1. Irq
3. Dma
4. StartDependentFunctions
5. EndDependentFunctions
6. Io
7. FixedIo
8. VendorSpecific
9. EndTag
10. Memory24
11. Memory32
12. FixedMemory32
13. Address16
14. Address32
15. ExtendedIrq

```

typedef union /* union of all resources */
{
    IRQ_RESOURCE                Irq;
    DMA_RESOURCE                Dma;
    START_DEPENDENT_FUNCTIONS_RESOURCE StartDependentFunctions;
    IO_RESOURCE                 Io;
    FIXED_IO_RESOURCE           FixedIo;
    VENDOR_RESOURCE             VendorSpecific;
    MEMORY24_RESOURCE           Memory24;
    MEMORY32_RESOURCE           Memory32;
    FIXED_MEMORY32_RESOURCE     FixedMemory32;
    ADDRESS16_RESOURCE          Address16;
    ADDRESS32_RESOURCE          Address32;
    EXTENDED_IRQ_RESOURCE       ExtendedIrq;

} RESOURCE_DATA;

typedef struct _resource_tag
{
    RESOURCE_TYPE                Id;
    UINT32                       Length;
    RESOURCE_DATA                Data;

} RESOURCE;
  
```

The `ACPI_BUFFER Pointer` points to a buffer of at least *Length* size. The buffer is filled with a series of `RESOURCE` entries, each of which begins with an *Id* that indicates the type of resource descriptor, a *Length* member and a *Data* member that is a `RESOURCE_DATA` union. The `RESOURCE_DATA` union can be any of fourteen different types of resource descriptors. The *Length* member will allow the caller to walk the `RESOURCE` entries. By incrementing a buffer walking pointer by *Length* bytes, the pointer will reference each succeeding table element. The final element in the list of `RESOURCE` entries will have an *Id* of `EndTag`. An `EndTag` entry contains no additional data.

When walking the `RESOURCE` entries, the *Id* member determines how to interpret the structure. For example, if the *Id* member evaluates to `StartDependentFunctions`, then the *Data* member is two 32-bit values, a `CompatibilityPriority` value and a `PerformanceRobustness` value. These values are interpreted using the constant definitions that are found in `actypes.h`, `GOOD_CONFIGURATION`, `ACCEPTABLE_CONFIGURATION` or `SUB_OPTIMAL_CONFIGURATION`. The interpretation of these constant definitions is discussed in the `Start Dependent Functions` section of the `ACPI` specification, Chapter 6.

As another, more complex example, consider a `RESOURCE` entry with an *Id* member that evaluates to `Address32`, then the *Data* member is an `ADDRESS32_RESOURCE` structure. The `ADDRESS32_RESOURCE` structure contains fourteen members that map to the data discussed in the `DWORD Address Space Descriptor` section of the `ACPI` specification, Chapter 6. The `Data.Address32.ResourceType` member is interpreted using the constant definitions `MEMORY_RANGE`, `IO_RANGE` or `BUS_NUMBER_RANGE`. This value also effects the interpretation of the `Data.Address32.Attribute` structure because it contains type specific information.

The `General Flags` discussed in the `ACPI` specification are interpreted and given separate members within the `ADDRESS32_RESOURCE` structure. Each of the bits in the `General Flags` that describe whether the maximum and minimum addresses is fixed or not, whether the address is subtractively or positively decoded and whether the resource simply consumes or both produces and consumes a resource are represented by the members `MaxAddressFixed`, `MinAddressFixed`, `Decode` and `ProducerConsumer` respectively.

The *Attribute* member is interpreted based upon the *ResourceType* member. For example, if the *ResourceType* is MEMORY_RANGE, then the *Attribute* member contains two 16-bit values, a *Data.Address32.Attribute.Memory.CacheAttribute* value and a *ReadWriteAttribute* value.

The *Data.Address32.Granularity*, *MinAddressRange*, *MaxAddressRange*, *AddressTranslationOffset* and *AddressLength* members are simply interpreted as UINT32 numbers.

The optional *Data.Address32.ResourceSourceIndex* is valid only if the *ResourceSourceStringLength* is non-zero. Although the *ResourceSource* member is defined as UINT8 ResourceSource[1], it can be de-referenced as a null-terminated string whose length is *ResourceSourceStringLength*.

4.4 Exception Codes

A common and consistent set of return codes is used throughout the ACPI subsystem. For example, all of the public ACPI interfaces return the exception AE_BAD_PARAMETER when an invalid parameter is detected.

The exception codes are contained in the public acexcep.h file.

The entire list of available exception codes is given below, along with a generic description of each code. See the description of each public primitive for a list of possible exceptions, along with specific reason(s) for each exception.

Table 4. Exception Code Values

<i>Exception Name</i>	<i>Typical Meaning</i>
AE_OK	No error
Environmental Exceptions	
AE_ERROR	Unspecified error
AE_NO_ACPI_TABLES	ACPI tables could not be found
AE_NO_NAMESPACE	A namespace has not been loaded
AE_NO_MEMORY	Insufficient dynamic memory
AE_NOT_FOUND	The name was not found in the namespace
AE_NOT_EXIST	A required entity does not exist
AE_EXIST	An entity already exists
AE_TYPE	The object type is incorrect
AE_NULL_OBJECT	A required object was missing
AE_NULL_ENTRY	The requested object does not exist
AE_BUFFER_OVERFLOW	The buffer provided is too small
AE_STACK_OVERFLOW	An internal stack overflowed
AE_STACK_UNDERFLOW	An internal stack underflowed
AE_NOT_IMPLEMENTED	The feature is not implemented
AE_VERSION_MISMATCH	An incompatible version was detected
AE_SUPPORT	The feature is not supported
AE_SHARE	There was a sharing violation
AE_LIMIT	A predefined limit was exceeded
AE_TIME	A time limit or timeout expired
AE_UNKNOWN_STATUS	An unknown status code was encountered

Exception Name	Typical Meaning
AE_ACQUIRE_DEADLOCK	Internal error - attempt was made to acquire a mutex in improper order
AE_RELEASE_DEADLOCK	Internal error - attempt was made to release a mutex in improper order
AE_NOT_ACQUIRED	An attempt to release a mutex or the Global Lock without a previous acquire
AE_ALREADY_ACQUIRED	Internal error - attempt was made to acquire a mutex twice
AE_NO_HARDWARE_RESPONSE	Hardware did not respond after an I/O operation
AE_NO_GLOBAL_LOCK	There is no hardware Global Lock
AE_ABORT_METHOD	A control method was aborted
Programmer Exceptions (ACPI external interfaces)	
AE_BAD_PARAMETER	A parameter is out of range or invalid
AE_BAD_CHARACTER	An invalid character was found in a name
AE_BAD_PATHNAME	An invalid character was found in a pathname
AE_BAD_DATA	A package or buffer contained incorrect data
AE_BAD_ADDRESS	An invalid physical address
AE_ALIGNMENT	A non-aligned buffer was received
AE_BAD_HEX_CONSTANT	Invalid character in a Hex constant
AE_BAD_OCTAL_CONSTANT	Invalid character in an Octal constant
AE_BAD_DECIMAL_CONSTANT	Invalid character in a Decimal constant
ACPI Table Exceptions	
AE_BAD_SIGNATURE	An ACPI table has an invalid signature
AE_BAD_HEADER	Invalid field in an ACPI table header
AE_BAD_CHECKSUM	An ACPI table checksum is not correct
AE_BAD_VALUE	An invalid value was found in a table
AE_TABLE_NOT_SUPPORTED	ACPI table is not consumed by the ACPI subsystem
AE_INVALID_TABLE_LENGTH	The FADT or FACS has improper length
AML (Interpreter) Exceptions	
AE_AML_ERROR	Unspecified AML error
AE_AML_PARSE	Invalid AML could not be parsed
AE_AML_BAD_OPCODE	Invalid AML opcode encountered
AE_AML_NO_OPERAND	An operand is missing (such as a method that did not return a required value)
AE_AML_OPERAND_TYPE	An operand of an incorrect type was encountered
AE_AML_OPERAND_VALUE	The operand had an inappropriate or invalid value
AE_AML_UNINITIALIZED_LOCAL	Method tried to use an uninitialized local variable
AE_AML_UNINITIALIZED_ARG	Method tried to use an uninitialized

Exception Name	Typical Meaning
	argument
AE_AML_UNINITIALIZED_ELEMENT	Method tried to use an empty package element
AE_AML_NUMERIC_OVERFLOW	Overflow during BCD conversion or other
AE_AML_REGION_LIMIT	Tried to access beyond the end of an Operation Region
AE_AML_BUFFER_LIMIT	Tried to access beyond the end of a buffer
AE_AML_PACKAGE_LIMIT	Tried to access beyond the end of a package
AE_AML_DIVIDE_BY_ZERO	During execution of AML Divide operator
AE_AML_BAD_NAME	An ACPI name contains invalid character(s)
AE_AML_NAME_NOT_FOUND	Could not resolve a named reference
AE_AML_INTERNAL	An internal error within the interpreter
AE_AML_INVALID_SPACE_ID	An Operation Region SpaceID is invalid
AE_AML_STRING_LIMIT	String is longer than 200 characters
AE_AML_NO_RETURN_VALUE	A method did not return a required value
AE_AML_NOT_OWNER	A thread tried to release a mutex that it does not own
AE_AML_MUTEX_ORDER	Mutex SyncLevel release mismatch
AE_AML_MUTEX_NOT_ACQUIRED	Attempt to release a mutex that was not previously acquired
AE_AML_INVALID_RESOURCE_TYPE	Invalid resource type in resource list
AE_AML_INVALID_INDEX	Invalid Argx or Localx (x too large)
AE_AML_REGISTER_LIMIT	Bank value or Index value beyond range of register
AE_AML_NO_WHILE	Break or Continue without a While
AE_AML_ALIGNMENT	Non-aligned memory transfer on platform that does not support this
AE_AML_NO_RESOURCE_END_TAG	No End Tag in a resource list
AE_AML_BAD_RESOURCE_VALUE	Invalid value of a resource element
AE_AML_CIRCULAR_REFERENCE	Two references refer to each other
Internal Exceptions used for control	
AE_CTRL_RETURN_VALUE	A Method returned a value
AE_CTRL_PENDING	Method is calling another method
AE_CTRL_TERMINATE	Terminate the executing method
AE_CTRL_TRUE	An If or While predicate result
AE_CTRL_FALSE	An If or While predicate result
AE_CTRL_DEPTH	Maximum search depth has been reached
AE_CTRL_END	An If or While predicate is false
AE_CTRL_TRANSFER	Transfer control to called method
AE_CTRL_BREAK	A Break has been executed
AE_CTRL_CONTINUE	A Continue has been executed

5 Subsystem Configuration

There are four methods of configuring the OS-independent ACPI Core Subsystem. The first is the per-machine configuration for machine-specific dependencies. The second is per-compiler configuration for compiler dependencies. The third configuration is compile-time configuration through the use of compiler switches. The fourth configuration method is via run-time global variables which are statically initialized from the configuration header file (This is really a combination of static compile-time configuration and run-time configuration).

5.1 Configuration Files

The ACPI CA subsystem has three types of configuration header files to allow the subsystem to be tailored to the particular machine and compiler, as well as allowing for the tuning of subsystem constants.

These three include files perform the subsystem configuration:

- An include file that is specific to the particular compiler being used to compile the ACPI CA subsystem provides macros and defines that must be implemented on a per-compiler basis. These files appear in the *Include/Platform* directory.
- An include file that is specific to the particular machine being targeted for the ACPI CA subsystem provides macros and defines that must be implemented on a per-machine basis. These files appear in the *Include/Platform* directory.
- A global include file, *acconfig.h* allows for the tailoring and tuning of various subsystem constants and options. This file appears in the *Include* directory

5.2 Per-Compiler Configuration

These macros and defines allow the ACPI CA subsystem to be tailored to a particular compiler.

5.2.1 ACPI_DIV_64_BY_32 (Short 64-bit Divide)

This macro performs a simple 64-bit divide with a 64-bit dividend and a 32-bit divisor. The point of this macro is to perform a short divide on 16-bit and 32-bit platforms without invoking a double-precision math library. Both the quotient and remainder must be returned.

5.2.2 ACPI_SHIFT_RIGHT_64 (64-bit Shift)

This macro performs a 64-bit right shift by one bit. The point of this macro is to perform a shift right on 16-bit and 32-bit platforms without invoking a double-precision math library.

5.2.3 ACPI_EXTERNAL_XFACE

This macro allows the definition of an interface type prefix (such as *_cdecl*, *pascal*, etc.) to be used in the declaration of all ACPI CA external interfaces (the **Acpi*** interfaces.)

5.2.4 **ACPI_INTERNAL_XFACE**

This macro allows the definition of an interface type prefix (such as `_cdecl`, `pascal`, etc.) to be used in the declaration of all ACPI CA internal interfaces.

5.2.5 **ACPI_INTERNAL_VAR_XFACE**

This macro allows the definition of an interface type prefix (such as `_cdecl`, `pascal`, etc.) to be used in the declaration of all ACPI CA variable-argument list internal interfaces.

5.2.6 **ACPI_SYSTEM_XFACE**

This macro allows the definition of an interface type prefix (such as `_cdecl`, `pascal`, etc.) to be used in the declaration of all interfaces to the host OS.

5.2.7 **ACPI_PRINTF_LIKE_FUNC**

This macro defines a suffix to be used in the definitions and prototypes of internal print functions that accept a printf-like format string. Some compilers have the ability to perform additional typechecking on such functions

5.2.8 **ACPI_UNUSED_VAR**

This macro defines a prefix to be used in the definition of variables that may not be used in a module (such as the `ACPI_MODULE_NAME`). This can prevent compiler warnings for such variables.

5.2.9 **COMPILER_DEPENDENT_INT64**

Defines the name of a signed 64-bit integer on for this compiler. This macro is required because there is (currently) no standard method to define 64-bit integers in the C language.

5.2.10 **COMPILER_DEPENDENT_UINT64**

Defines the name of an unsigned 64-bit integer on for this compiler. This macro is required because there is (currently) no standard method to define 64-bit integers in the C language.

5.3 **Per-Machine Configuration**

These macros and defines allow the ACPI CA subsystem to be tailored to a particular machine or machine architecture.

5.3.1 **ACPI_ASM_MACROS**

When defined, this symbol indicates that the per-machine defaults are not to be used – the per-machine configuration has been fully specified in a per-machine configuration file.

5.3.2 ACPI_FLUSH_CPU_CACHE

Defines the instruction or instructions necessary to flush the CPU cache(s) on this machine.

5.3.3 ACPI_MACHINE_WIDTH

This macro defines the standard integer width of the target machine, either 16, 32, or 64.

5.3.4 ACPI_OS_NAME

This macro defines the string that is returned by the predefined “_OS_” method in the ACPI namespace.

5.3.5 ACPI_USE_STANDARD_HEADERS

This switch allows the use of a system-supplied C library for the Clib functions used by the subsystem. If this switch is not set, the subsystem uses its own implementations of these functions. Use of a system C library (when available) may be more efficient in terms of reused system code and efficiency of the function implementations.

5.3.6 ACPI_ACQUIRE_GLOBAL_LOCK

This macro defines the code (typically assembly code) necessary to acquire the ACPI Global Lock on this machine.

5.3.7 ACPI_RELEASE_GLOBAL_LOCK

This macro defines the code (typically assembly code) necessary to release the ACPI Global Lock on this machine.

5.4 Other Compile-time Configuration

The subsystem is configured at compile time via various compiler switches that are described below.

5.4.1 ACPI_APPLICATION

This switch should be set when the entire ACPI subsystem is to be run as an application on top of an operating system instead of a driver integrated with the kernel.

5.4.2 ACPI_DEBUG

This switch enables the DEBUG_PRINT macro and various other debugging support within the core subsystem. The code for the DEBUG_PRINT macro is only generated when the ACPI_DEBUG switch is set; otherwise the macro is defined to be null and thus all debug code is compiled out.

5.4.3 **PARSER_ONLY**

This switch is used by applications that only use the AML parser, not the interpreter. An example application is the *AcpiDump* utility that simply disassembles the AML code, it does not attempt to interpret the code.

5.5 **Configuration of Subsystem Constants**

The configurable subsystem constants are specified in the *Include/acconfig.h* header file. These constants may be modified at either compile time by changing the constants in *acconfig.h*, or at run-time by changing the contents of the global variables where these constants are stored.

5.5.1 **MAX_STATE_CACHE_DEPTH**

The maximum number of objects in the generic state object cache used to avoid recursive calls within the subsystem. These are small objects, but are used frequently. A larger cache will improve the performance of the entire subsystem (loading tables, parsing methods, and executing methods.)

5.5.2 **MAX_PARSE_CACHE_DEPTH**

The maximum number of objects in the parse object cache. These are the objects used to build parse trees. A larger cache will improve the execution performance of control methods (when the parse just-in-time strategy is used) by improving the time to parse the AML.

5.5.3 **MAX_OBJECT_CACHE_DEPTH**

The maximum number of objects in the interpreter operand object cache. These objects are used during control methods to pass the operands for individual AML opcodes to the interpreter. A larger cache will improve the performance of control method execution

5.5.4 **MAX_WALK_CACHE_DEPTH**

The maximum number of objects in the parse tree walk object cache. These are relatively large objects (about 512 bytes) that are used to contain the entire state of a control method during its execution. Each nested control method requires an additional walk object. Since only one object is required per control method, it is not necessary to cache a large number of these objects. A few cached walk objects are sufficient to increase the performance of control method execution and reduce memory fragmentation.

6 ACPI Core Subsystem - External Interface Definition

This section contains documentation for the specific interfaces exported by the ACPI Core. The interfaces are grouped based upon their functionality. These groups are closely related to the internal modules (or sub-components) of the Core Subsystem described earlier in this document. These interfaces are intended to be used by the OSL only. The host OS does not call these interfaces directly. All interfaces to the ACPI Core Subsystem are prefixed by the letters “Acpi”.

6.1 Subsystem Initialization, Shutdown, and Status

6.1.1 AcpiInitializeSubsystem

Initialize all ACPI components.

ACPI_STATUS
AcpiInitializeSubsystem (
 void)

PARAMETERS

None

RETURN

Status Exception code that indicates success or reason for failure.

EXCEPTIONS

- AE_OK The subsystem was successfully initialized.
- AE_ERROR The system is not capable of supporting ACPI mode.
- AE_NO_MEMORY Insufficient dynamic memory to complete the ACPI initialization.

Functional Description:

This function initializes the entire ACPI subsystem, including the OS Services Layer. It must be called once before any of the other **Acpi*** interfaces are called.

6.1.2 AcpiInstallInitializationHandler

Install a global handler for initialization handling.

ACPI_STATUS
AcpiInstallInitializationHandler (
ACPI_INIT_HANDLER **Handler,**
UINT32 **Function)**

PARAMETERS

Handler	A pointer to the initialization handler.
Function	Reserved.

EXCEPTIONS

AE_OK	The ACPI namespace was successfully loaded and initialized.
AE_BAD_PARAMETER	The <i>Handler</i> parameter is invalid.
AE_ALREADY_EXISTS	A global initialization handler has already been installed.

Functional Description:

This function installs a global initialization handler that is called during the subsystem initialization.

Currently, the handler is called after each Device object within the namespace has been initialized (The `_INI` and `_STA` methods have been run on the device.)

6.1.2.1 Interface to User Callback Function

Interface to the user function that is installed via *AcpiInstallInitializationHandler*.

ACPI_STATUS (*ACPI_INIT_HANDLER) (
ACPI_HANDLE **Object,**
UINT32 **Function)**

PARAMETERS

Object	A handle for the object that is being or has just been initialized.
Function	One of the following manifest constants: ACPI_INIT_DEVICE_INI – the Object is a handle to a Device that has just been initialized.

RETURN VALUE

Status	AE_OK	Continue the walk
--------	-------	-------------------

AE_TERMINATE	Stop the walk immediately
AE_DEPTH	Go no deeper into the namespace tree
All others	Abort the walk with this exception code

Functional Description:

This function is called during subsystem initialization.

6.1.3 AcpiEnableSubsystem

Complete the ACPI Subsystem initialization and enable ACPI operations.

ACPI_STATUS
AcpiEnableSubsystem (
UINT32

Flags)

PARAMETERS

Flags

Specifies how the subsystem should be initialized. Must be one of these manifest constants:

ACPI_FULL_INITIALIZATION – Perform completed initialization. This is the normal use of this interface

ACPI_NO_ADDRESS_SPACE_INIT. Do not install the default address space handlers. For debug purposes only.

ACPI_NO_HARDWARE_INIT. Do not initialize the ACPI hardware. For hardware-independent mode only.

ACPI_NO_EVENT_INIT. Do not install an SCI handler and do not initialize ACPI events. For hardware independent mode only

ACPI_NO_ACPI_ENABLE. Do not attempt to enter ACPI mode. For hardware-independent mode only.

ACPI_NO_PCI_INIT. When running _INI methods, do not attempt to recognize and initialize the PCI Root Bridges.

RETURN

Status

Exception code that indicates success or reason for failure.

EXCEPTIONS

AE_OK

The ACPI namespace was successfully loaded and initialized.

AE_NO_MEMORY

Insufficient memory to build the internal namespace.

Functional Description:

This function completes initialization of the ACPI Subsystem.

6.1.4 AcpiInitializeObjects

Initialize objects within the ACPI namespace.
--

ACPI_STATUS
AcpiInitializeObjects (
 UINT32

Flags)

PARAMETERS

Flags

Specifies how the subsystem should be initialized. Must be one of these manifest constants:

ACPI_NO_DEVICE_INIT. Do not attempt to run the **_INI** methods on devices in the ACPI namespace.

ACPI_NO_OBJECT_INIT. Do not run the final initialization pass to complete initialization of all address spaces and Fields.

RETURN

Status

Exception code that indicates success or reason for failure.

EXCEPTIONS

AE_OK

The ACPI namespace was successfully loaded and initialized.

AE_NO_MEMORY

Insufficient memory to build the internal namespace.

Functional Description:

This function completes initialization of the ACPI Subsystem by initializing all ACPI Devices, Operation Regions, Buffer Fields, Buffers, and Packages. It must be called and it should only be called after a call to *AcpiEnableSubsystem*. The object cache is purged after these objects are initialized, in case an overly large number of cached objects were created during initialization (versus the size of the caches at runtime.)

6.1.5 AcpiGetSystemInfo

Get global ACPI-related system information.
--

ACPI_STATUS
AcpiGetSystemInfo (
 ACPI_BUFFER

***OutBuffer)**

PARAMETERS

OutBuffer A pointer to a location where the system information is to be returned.

RETURN VALUE

Status Exception code that indicates success or reason for failure.

EXCEPTIONS

AE_OK The system information list was successfully returned.

AE_BAD_PARAMETER At least one of the following is true:

- The *OutBuffer* pointer is NULL.
- The *Length* field of *OutBuffer* is not `ACPI_ALLOCATE_BUFFER`, but the *Pointer* field of *OutBuffer* is NULL.

AE_BUFFER_OVERFLOW The *Length* field of *OutBuffer* indicates that the buffer is too small to hold the system information. Upon return, the *Length* field contains the minimum required buffer length.

Functional Description:

This function obtains information about the current state of the ACPI system. It will return system information in the *OutBuffer* structure. Upon completion the *Length* field of *OutBuffer* will indicate the number of bytes copied into the *Pointer* field of the *OutBuffer* buffer. This routine will never return a partial resource structure.

If the function fails an appropriate status will be returned and the value of *OutBuffer* is undefined.

The structure that is returned in *OutBuffer* is defined as follows:

```
typedef struct _AcpiSysInfo
{
    UINT32          AcpiCaVersion;
    UINT32          Flags;
    UINT32          TimerResolution;
    UINT32          Reserved1;
    UINT32          Reserved2;
    UINT32          DebugLevel;
    UINT32          DebugLayer;
    UINT32          NumTableTypes;
    ACPI_TABLE_INFO TableInfo[ NUM ACPI TABLES ];
} ACPI_SYSTEM_INFO;
```

Where:

AcpiCaVersion Version number of the ACPI CA core subsystem, in the form 0xYYYYMMDD.

Flags Static information about the system:

	SYS_MODE ACPI	ACPI mode is supported on this system.
	SYS_MODE_LEGACY	Legacy mode is supported.
TimerResolution		Resolution of the ACPI Power Management Timer. Either 24 or 32 indicating the corresponding number of bits of resolution.
DebugLevel		Current value of the global variable that controls the debug output verbosity.
DebugLayer		Current value of the global variable that controls the internal layers whose debug output is enabled.
NumTableTypes		Number of ACPI types that are directly supported by the subsystem (FADT, FACS, DSDT, etc.)
TableInfo		One entry per table type indicating the number of tables of that type that are loaded.

6.1.6 AcpiSubsystemStatus

Obtain initialization status of the ACPI subsystem.

ACPI_STATUS
AcpiSubsystemStatus (
void)

PARAMETERS

None

RETURN

Status Exception code indicates success or reason for failure.

EXCEPTIONS

AE_OK The subsystem was successfully initialized.

AE_ERROR The subsystem has not been initialized

Functional Description:

This function allows device drivers to determine the initialization status of the ACPI subsystem.:

6.1.7 AcpiFormatException

Return the ASCII name of an ACPI exception code.

```
const char *
AcpiFormatException (
    ACPI_STATUS          Status)
```

PARAMETERS

Status The ACPI status/exception code to be translated.

RETURN VALUE

Exception String A pointer to the formatted exception string.

EXCEPTIONS

None

Functional Description:

This function converts an ACPI exception code into a human-readable string. It returns the exception name string as the function return value. The string is a const value that does not require deletion by the caller.

6.1.8 AcpiPurgeCachedObjects

Empty all internal object caches.

```
ACPI_STATUS
AcpiPurgeCachedObjects (
    void)
```

PARAMETERS

None

RETURN

Status Exception code indicates success or reason for failure.

EXCEPTIONS

AE_OK The caches were successfully purged.

Functional Description:

This function purges all internal object caches, freeing all memory blocks: It can be used to purge the cache after particularly large operations, or the cache can be periodically flushed to ensure that no large amounts of stagnant cache objects are present.

6.1.9 AcpiTerminate

Shutdown all ACPI Components.

ACPI_STATUS
AcpiTerminate (
 void)

PARAMETERS

None

RETURN

Status	Exception code indicates success or reason for failure.
--------	---

EXCEPTIONS

AE_OK	The subsystem was successfully shutdown.
AE_ERROR	TBD!!

Functional Description:

This function performs a shutdown of the Core Subsystem portion of the ACPI subsystem. The namespace tables are unloaded, and all resources are freed to the host operating system. This function should be called prior to unloading the ACPI subsystem. In more detail, the terminate function performs the following:

- Free all memory associated with the ACPI tables (either allocated or mapped memory).
- Free all internal objects associated with the namespace.
- Free all objects within the object caches.
- Free all OS resources associated with mutual exclusion.

6.2 Memory Management

The ACPI core subsystem provides memory management services that are built upon the memory management services exported by the OS services layer. If enabled (in debug mode), the core memory manager tracks and logs each allocation to detect the following conditions:

- 1) Detect attempts to release (free) an allocated memory block more than once.
- 2) Detect memory leaks by keeping a list of all outstanding allocated memory blocks. This list can be examined at any time; however, the best time to find memory leaks is after the subsystem is shutdown -- any remaining allocations represent leaked blocks.

Do not mix memory manager calls. In other words, if the Acpi* memory manager is used to allocate memory, do not free memory via the OS Services Layer (AcpiOsFree), via the C library (free), or directly call the OS memory management primitives.

6.2.1 AcpiAllocate

Allocate memory from the dynamic memory pool.

```
void *
AcpiAllocate (
    UINT32          Size)
```

PARAMETERS

Size	Amount of memory to allocate.
------	-------------------------------

RETURN VALUE

Memory	A pointer to the allocated memory. A NULL pointer is returned on error.
--------	---

Functional Description:

This function dynamically allocates memory. The returned memory cannot be assumed to be initialized to any particular value or values.

6.2.2 AcpiCAllocate

Allocate and initialize memory.

```
void *
AcpiCAllocate (
    UINT32          Size)
```

PARAMETERS

Size	Amount of memory to allocate.
------	-------------------------------

RETURN VALUE

Memory	A pointer to the allocated memory. A NULL pointer is returned on error.
--------	---

Functional Description:

This function dynamically allocates and initializes memory. The returned memory is guaranteed to be initialized to all zeros.

6.2.3 AcpiFree

Free previously allocated memory.
--

```
void  
AcpiFree (  
    void                *Memory)
```

PARAMETERS

Memory	A pointer to the memory to be freed.
--------	--------------------------------------

RETURN VALUE

None

Functional Description:

This function frees memory that was previously allocated via *AcpiAllocate* or *AcpiAllocate*.

6.3 ACPI Hardware Management

6.3.1 AcpiEnable

Put the system into ACPI mode.

ACPI_STATUS

AcpiEnable (
void)

PARAMETERS

None

RETURN VALUE

Status Exception code that indicates success or reason for failure.

EXCEPTIONS

AE_OK ACPI mode was successfully enabled.

AE_ERROR Either ACPI mode is not supported by this system (legacy mode only), the SCI interrupt handler could not be installed, or the system could not be transitioned into ACPI mode.

AE_NO_ACPI_TABLES The ACPI tables have not been successfully loaded.

Functional Description:

This function enables ACPI mode on the host computer system. It ensures that the system control interrupt (SCI) is properly configured, disables SCI event sources, installs the SCI handler, and transfers the system hardware into ACPI mode.

6.3.2 AcpiDisable

Take the system out of ACPI mode.

ACPI_STATUS

AcpiDisable (
void)

PARAMETERS

None

RETURN VALUE

Status	Exception code that indicates success or reason for failure.
--------	--

EXCEPTIONS

AE_OK	ACPI mode was successfully disabled.
AE_ERROR	The system could not be transitioned out of ACPI mode.

Functional Description:

This function disables ACPI mode on the host computer system. It returns the system hardware to original ACPI/legacy mode, disables all events, and removes the SCI interrupt handler.

6.3.3 AcpiGetRegister

Get the contents of an ACPI bit-defined Register.

ACPI_STATUS**AcpiGetRegister (**

UINT32
 UINT32
 UINT32

RegisterId,
***Value,**
Flags)

PARAMETERS

RegisterId	The ID of the desired register, one of the following manifest constants: ACPI_BITREG_TIMER_STATUS ACPI_BITREG_BUS_MASTER_STATUS ACPI_BITREG_GLOBAL_LOCK_STATUS ACPI_BITREG_POWER_BUTTON_STATUS ACPI_BITREG_SLEEP_BUTTON_STATUS ACPI_BITREG_RT_CLOCK_STATUS ACPI_BITREG_WAKE_STATUS ACPI_BITREG_TIMER_ENABLE ACPI_BITREG_GLOBAL_LOCK_ENABLE ACPI_BITREG_POWER_BUTTON_ENABLE ACPI_BITREG_SLEEP_BUTTON_ENABLE ACPI_BITREG_RT_CLOCK_ENABLE ACPI_BITREG_WAKE_ENABLE ACPI_BITREG_SCI_ENABLE ACPI_BITREG_BUS_MASTER_RLD ACPI_BITREG_GLOBAL_LOCK_RELEASE ACPI_BITREG_SLEEP_TYPE_A ACPI_BITREG_SLEEP_TYPE_B ACPI_BITREG_SLEEP_ENABLE ACPI_BITREG_ARB_DISABLE.
------------	--

Value	A pointer to a location where the data is to be returned.
Flags	Indicates whether the ACPI hardware should be locked or not. If calling this interface with interrupts disabled, use: <code>ACPI_MTX_DO_NOT_LOCK</code> . Otherwise, use <code>ACPI_MTX_LOCK</code> .

RETURN VALUE

Status	Exception code that indicates success or reason for failure.
--------	--

EXCEPTIONS

<code>AE_OK</code>	The register was read successfully.
<code>AE_BAD_PARAMETER</code>	Invalid RegisterId.
Other	The function failed at the operating system level.

Functional Description:

This function reads the bit register specified in the RegisterId. The value returned is normalized to bit zero. Can be used with interrupt enabled or disabled.

6.3.4 AcpiSetRegister

Get the contents of an ACPI bit-defined Register.

ACPI_STATUS
AcpiSetRegister (
 UINT32
 UINT32
 UINT32

RegisterId,
Value,
Flags)

PARAMETERS

RegisterId	The ID of the desired register, one of the following manifest constants: <code>ACPI_BITREG_TIMER_STATUS</code> <code>ACPI_BITREG_BUS_MASTER_STATUS</code> <code>ACPI_BITREG_GLOBAL_LOCK_STATUS</code> <code>ACPI_BITREG_POWER_BUTTON_STATUS</code> <code>ACPI_BITREG_SLEEP_BUTTON_STATUS</code> <code>ACPI_BITREG_RT_CLOCK_STATUS</code> <code>ACPI_BITREG_WAKE_STATUS</code> <code>ACPI_BITREG_TIMER_ENABLE</code> <code>ACPI_BITREG_GLOBAL_LOCK_ENABLE</code> <code>ACPI_BITREG_POWER_BUTTON_ENABLE</code> <code>ACPI_BITREG_SLEEP_BUTTON_ENABLE</code> <code>ACPI_BITREG_RT_CLOCK_ENABLE</code> <code>ACPI_BITREG_WAKE_ENABLE</code>
------------	--



ACPI_BITREG_SCI_ENABLE
 ACPI_BITREG_BUS_MASTER_RLD
 ACPI_BITREG_GLOBAL_LOCK_RELEASE
 ACPI_BITREG_SLEEP_TYPE_A
 ACPI_BITREG_SLEEP_TYPE_B
 ACPI_BITREG_SLEEP_ENABLE
 ACPI_BITREG_ARB_DISABLE.

Value	The data to be written.
Flags	Indicates whether the ACPI hardware should be locked or not. If calling this interface with interrupts disabled, use: ACPI_MTX_DO_NOT_LOCK. Otherwise, use ACPI_MTX_LOCK.

RETURN VALUE

Status	Exception code that indicates success or reason for failure.
--------	--

EXCEPTIONS

AE_OK	The register was read successfully.
AE_BAD_PARAMETER	Invalid RegisterId.
Other	The function failed at the operating system level.

Functional Description:

This function reads the bit register specified in the RegisterId. The value written must be normalized to bit zero before calling. Can be used with interrupt enabled or disabled.

6.3.5 AcpiSetFirmwareWakingVector

Set the ROM BIOS wake vector.

ACPI_STATUS
AcpiSetFirmwareWakingVector (
 void ***Vector)**

PARAMETERS

Vector	The physical address to be stored in the waking vector.
--------	---

RETURN VALUE

Status	Exception code that indicates success or reason for failure.
--------	--

EXCEPTIONS

AE_OK	The vector was set successfully.
-------	----------------------------------

AE_NO_ACPI_TABLES The FACS is not loaded or could not be found

Functional Description:

This function sets the firmware (ROM BIOS) wake vector.

If the function fails an appropriate status will be returned and the value of the waking vector will be undisturbed.

6.3.6 AcpiGetFirmwareWakingVector

Get the current value of the ROM BIOS wake vector.

ACPI_STATUS
 AcpiGetFirmwareWakingVector (
 void **OutVector)

PARAMETERS

OutVector A pointer to a location where the current vector (physical address) is to be returned.

RETURN VALUE

Status Exception code that indicates success or reason for failure.

EXCEPTIONS

AE_OK The vector was successfully returned.

AE_BAD_PARAMETER The OutVector pointer is NULL.

AE_NO_ACPI_TABLES The FACS is not loaded or could not be found

Functional Description:

This function obtains the BIOS wake vector. This address is returned as a (void *) physical address.

If the function fails an appropriate status will be returned and the value of the *OutVector* location will be undetermined.

6.3.7 AcpiGetSleepTypeData

Get the SLP_TYP data for the requested sleep state.

ACPI_STATUS

```
AcpiGetSleepTypeData (
    UINT8                SleepState,
    UINT8                *SleepTypeA,
    UINT8                *SleepTypeB)
```

PARAMETERS

SleepState	The SleepState value (0 through 5) for which the SLP_TYPa and SLP_TYPb values will be returned.
SleepTypeA	A pointer to a location where the value of SLP_TYPa will be returned.
SleepTypeB	A pointer to a location where the value of SLP_TYPb will be returned.

RETURN VALUE

Status	Exception code that indicates success or reason for failure.
--------	--

EXCEPTIONS

AE_OK	Both SLP_TYP values were returned successfully.
AE_BAD_PARAMETER	Either SleepState has an invalid value, or one of the SleepType pointers is invalid.
AE_AML_NO_OPERAND	Could not locate one or more of the SLP_TYP values.
AE_AML_OPERAND_TYPE	One or more of the SLP_TYP objects was not a numeric type.

Functional Description:

This function returns the SLP_TYP object for the requested sleep state.

6.3.8 AcpiEnterSleepStatePrep

Prepare to enter a system sleep state (S1-S5).

ACPI_STATUS
AcpiEnterSleepStatePrep (
 UINT8 **SleepState)**

PARAMETERS

SleepState	The sleep state to prepare to enter. Must be in the range 1 through 5.
------------	--

RETURN VALUE

Status	Exception code that indicates success or reason for failure.
--------	--

EXCEPTIONS

AE_OK	The PTS and GTS methods were successfully run
Other	Exception from AcpiEvaluateObject.

Functional Description:

Prepare to enter a system sleep state.
 This function evaluates the _PTS and _GTS methods.

6.3.9 AcpiEnterSleepState

Enter a system sleep state (S1-S5).

ACPI_STATUS
AcpiEnterSleepState (
 UINT8 **SleepState)**

PARAMETERS

SleepState	The sleep state to enter. Must be in the range 1 through 5.
------------	---

RETURN VALUE

Status	Exception code that indicates success or reason for failure.
--------	--

EXCEPTIONS

AE_OK	The sleep state (S1) was successfully entered.
Other	Hardware access exception.

Functional Description:

This function only returns for transitions to the S1 state or when an error occurs. Sleep states S2-S4 use the firmware waking vector during wakeup.

This function must be called with interrupts disabled.

6.3.10 AcpiLeaveSleepState

Leave (cleanup) a system sleep state (S1-S5).

ACPI_STATUS
AcpiLeaveSleepState (
 UINT8

SleepState)

PARAMETERS

SleepState The sleep state to leave.

RETURN VALUE

Status Exception code that indicates success or reason for failure.

EXCEPTIONS

AE_OK The cleanup was successful.

Other Hardware access exception.

Functional Description:

Perform cleanup after leaving a sleep state.

6.3.11 AcpiAcquireGlobalLock

Acquire the ACPI Global Lock.

ACPI_STATUS
AcpiAcquireGlobalLock (
 UINT32
 UINT32

Timeout,
*OutHandle)

PARAMETERS

Timeout The maximum time (in System Ticks) the caller is willing to wait for the global lock.

OutHandle A pointer to where a handle to the lock is to be returned. This handle is required to release the global lock.

RETURN VALUE

Status	Exception code that indicates success or reason for failure.
--------	--

EXCEPTIONS

AE_OK	The global lock was successfully acquired.
AE_BAD_PARAMETER	The <i>OutHandle</i> pointer is NULL.
AE_TIME	The global lock could not be acquired within the specified time limit.

Functional Description:

This function obtains exclusive access to the single system-wide ACPI Global Lock. The purpose of the global lock is to ensure exclusive access to resources that must be shared between the operating system and the firmware.

6.3.12 AcpiReleaseGlobalLock

Release the ACPI Global Lock.

ACPI_STATUS
AcpiReleaseGlobalLock (
 UINT32 **Handle)**

PARAMETERS

Handle	The handle that was obtained when the Global Lock was acquired. This allows different threads to acquire and release the lock, as long as they share the handle.
--------	--

RETURN VALUE

Status	Exception code that indicates success or reason for failure.
--------	--

EXCEPTIONS

AE_OK	The global lock was successfully released
AE_BAD_PARAMETER	The Handle is invalid.

Functional Description:

This function releases the global lock. The releasing thread may be different from the thread that acquired the lock. However, the Handle must be the same handle that was returned by *AcpiAcquireGlobalLock*.

6.3.13 AcpiGetTimerResolution

Get the resolution of the ACPI Power Management Timer.

ACPI_STATUS
AcpiGetTimerResolution (
UINT32 ***OutValue)**

PARAMETERS

OutValue A pointer to where the current value of the PM Timer resolution is to be returned.

RETURN VALUE

Status Exception code that indicates success or reason for failure.

EXCEPTIONS

AE_OK The PM Timer resolution was successfully retrieved and returned.

AE_BAD_PARAMETER The OutValue pointer is NULL.

Functional Description:

This function returns the PM Timer resolution – either 24 (for 24-bit) or 32 (for 32-bit timers).

6.3.14 AcpiGetTimerDuration

Calculates the time elapsed (in microseconds) between two values of the ACPI Power Management Timer.

ACPI_STATUS
AcpiGetTimer (
UINT32 **StartTicks,**
UINT32 **EndTicks,**
UINT32 ***OutValue)**

PARAMETERS

StartTicks The value of the PM Timer at the start of a time measurement (obtained by calling AcpiGetTimer).

EndTicks The value of the PM Timer at the end of a time measurement (obtained by calling AcpiGetTimer).

OutValue A pointer to where the elapsed time (in microseconds) is to be returned.

RETURN VALUE

Status	Exception code that indicates success or reason for failure.
--------	--

EXCEPTIONS

AE_OK	The time elapsed was successfully calculated and returned.
AE_BAD_PARAMETER	The OutValue pointer is NULL.

Functional Description:

This function calculates and returns the time elapsed (in microseconds) between StartTicks and EndTicks, taking into consideration the PM Timer frequency, resolution, and counter rollovers.

- AcpiWriteRegister

6.3.15 AcpiGetTimer

Get the current value of the ACPI Power Management Timer.
--

ACPI_STATUS
AcpiGetTimer (
UINT32

***OutValue)**

PARAMETERS

OutValue	A pointer to where the current value of the ACPI Timer is to be returned.
----------	---

RETURN VALUE

Status	Exception code that indicates success or reason for failure.
--------	--

EXCEPTIONS

AE_OK	The current value of the timer was successfully retrieved and returned.
AE_BAD_PARAMETER	The OutValue pointer is NULL.

Functional Description:

This function returns the current value of the PT Timer (in ticks).

6.4 ACPI Table Management

6.4.1 AcpiGetFirmwareTable

Obtain a firmware-supplied ACPI table.

ACPI_STATUS

AcpiGetFirmwareTable (

ACPI_STRING

UINT32

UINT32

ACPI_TABLE_HEADER

TableSignature,

TableInstance,

Flags,

**Table)

PARAMETERS

TableSignature	A string containing the ACPI-defined ASCII signature of the desired table
TableInstance	If multiple instances of the table are allowed.
Flags	Current addressing mode of the processor – whether paging is currently enabled or not – one of these manifest constants: ACPI_PHYSICAL_ADDRESSING ACPI_LOGICAL_ADDRESSING
Table	A pointer to where the address of the requested ACPI table is returned.

RETURN VALUE

Status	Exception code that indicates success or reason for failure.
--------	--

EXCEPTIONS

AE_OK	The requested table was found and returned.
AE_NO_ACPI_TABLES	A valid RSDP could not be located.
AE_NO_MEMORY	Insufficient dynamic memory to complete the operation.

Functional Description:

This function locates and returns one of the ACPI tables that are supplied by the system firmware. On IA-32 systems, this involves scanning within the first megabyte of physical memory for the RSDP signature.

This function may be called at any time, even before the ACPI subsystem has been initialized. This allows early access to ACPI tables -- even before the system virtual memory manager has been started.

If the operation fails an appropriate status will be returned and the value of *Table* is undefined.

6.4.2 AcpiFindRootPointer

Locate the RSDP via memory scan.

ACPI_STATUS
AcpiFindRootPointer (
 UINT32
 ACPI_POINTER

Flags,
***RsdpPhysicalAddress)**

PARAMETERS

Flags	Current addressing mode of the processor – whether paging is currently enabled or not – one of these manifest constants: ACPI_PHYSICAL_ADDRESSING ACPI_LOGICAL_ADDRESSING
RsdpPhysicalAddress	A pointer to where the physical address of the ACPI RSDP table will be returned.

RETURN VALUE

Status	Exception code that indicates success or reason for failure.
--------	--

EXCEPTIONS

AE_OK	The RSDP was found and returned.
AE_NO_ACPI_TABLES	A valid RSDP could not be located.
AE_NO_MEMORY	Insufficient dynamic memory to complete the operation.

Functional Description:

This function locates and returns the ACPI Root System Description Pointer by scanning within the first megabyte of physical memory for the RSDP signature. This mechanism is only applicable to IA-32 systems.

This interface should only be called from the OSL function *AcpiOsGetRootPointer* if the memory scanning mechanism is appropriate for the current platform.

If the operation fails an appropriate status will be returned and the value of *RsdpPhysicalAddress* is undefined.

6.4.3 AcpiLoadTables

Load core ACPI tables and build an internal ACPI namespace.
--

ACPI_STATUS
AcpiLoadTables (
void)

PARAMETERS

None

RETURN VALUE

Status	Exception code that indicates success or reason for failure.
--------	--

EXCEPTIONS

AE_OK	The table was successfully loaded and a handle returned.
AE_BAD_CHECKSUM	The computed table checksum does not match the checksum in the table.
AE_BAD_HEADER	The table header is invalid or is not a valid type.
AE_NO_ACPI_TABLES	The ACPI tables (RSDT, DSDT, FADT, etc.) could not be found in physical memory.
AE_NO_MEMORY	Insufficient dynamic memory to complete the operation.

Functional Description:

This function loads the ACPI tables that are pointed to by the RSDP/RSDT and installs them into the internal ACPI namespace database. The *Root System Description Pointer* (RSDP) points to the *Root System Description Table* (RSDT), and the remaining ACPI tables are found via pointers contained in RSDT.

The minimum required set of ACPI tables that will allow the ACPI CA core subsystem to initialize consists of the following:

- ◆ RSDT/XSDT
- ◆ FADT
- ◆ FACS
- ◆ DSDT

Only tables that are used directly by the ACPI subsystem are loaded. Other tables (such as the MADT, SRAT, etc.) are obtained and consumed by different kernel subsystems and/or device drivers.

If the operation fails an appropriate status will be returned.

6.4.4 AcpiLoadTable

Load an ACPI table from a buffer.
--

```

ACPI_STATUS
AcpiLoadTable (
    ACPI_TABLE_HEADER    *Table)
  
```

PARAMETERS

Table	A pointer to a buffer containing the entire table to be loaded.
-------	---

RETURN VALUE

Status	Exception code that indicates success or reason for failure.
--------	--

EXCEPTIONS

AE_OK	The table was successfully loaded and a handle returned.
AE_BAD_CHECKSUM	The computed table checksum does not match the checksum in the table.
AE_BAD_HEADER	The table header is invalid.
AE_BAD_PARAMETER	At least one of the following is true: <ul style="list-style-type: none"> The <i>Table</i> pointer is NULL.
AE_BAD_SIGNATURE	The signature field in the table header is not one of the supported table types.
AE_NO_MEMORY	Insufficient dynamic memory to complete the operation.

Functional Description:

This function is loads a single ACPI table from the caller's buffer and installs it into the internal ACPI namespace database. The buffer must contain an entire ACPI Table including a valid header. The header fields are verified, and the call will fail if it is determined that the table is invalid.

The table type (DSDT, FACS, etc.) is determined from the signature in the table header. See the ACPI_TABLE_TYPE data type for the supported table types.

Any previously loaded table of the same table type is automatically unloaded before the new table is installed.

If the call fails an appropriate status will be returned and the value of *OutTableHandle* is undefined.

6.4.5 AcpiUnloadTable

Unload a previously loaded ACPI table.

ACPI_STATUS
AcpiUnloadTable (
 ACPI_TABLE_TYPE **Type)**

PARAMETERS

Type	The type of the table to be unloaded. This must be a table loaded by either the <i>AcpiLoadTable</i> or the <i>AcpiLoadFirmware</i> functions.
------	--

RETURN VALUE

Status	Exception code that indicates success or reason for failure.
--------	--

EXCEPTIONS

AE_OK	The table was successfully unloaded.
AE_BAD_PARAMETER	The Type is invalid.
AE_NOT_EXIST	There is no table of this type currently loaded.

Functional Description:

This function unloads a previously loaded table. The table may have been loaded from the firmware or from a call to the *AcpiLoadTable* interface. For table types that allow multiple table (SSDT, PSDT), all tables of the given type are unloaded.

6.4.6 AcpiGetTableHeader

Get the header portion of a loaded ACPI table.

ACPI_STATUS
AcpiGetTableHeader (
 ACPI_TABLE_TYPE **TableType,**
 UINT32 **Instance**
 ACPI_TABLE_HEADER ***OutTableHeader)**

PARAMETERS

TableType	One of the defined ACPI table types.
Instance	For table types that support multiple tables, the instance of the table to be returned. For table types that support only a single table, this parameter must be set to one.

OutTableHeader A pointer to a location where the table header is to be returned.

RETURN VALUE

Status Exception code that indicates success or reason for failure.

EXCEPTIONS

AE_OK The table header was successfully located and returned.

AE_BAD_PARAMETER At least one of the following is true:

- The TableType is invalid.
- The OutTableHeader pointer is NULL.
- The table type only supports single tables, and the Instance is not one.

AE_NOT_EXIST There is no table of this type currently loaded, or the table of the specified Instance is not loaded.

AE_TYPE The table Type is not supported (RSDP).

Functional Description:

This function obtains the header of an installed ACPI table. The header contains a length field that can be used to determine the size of the buffer needed to contain the entire table. This function is not valid for the RSDP table since it does not have a standard header and is fixed length.

For table types that support more than one table, the *Instance* parameter is used to specify which table header of the given type should be returned. For table types that only support single tables, the *Instance* parameter must be set to one.

If the operation fails an appropriate status will be returned and the contents of *OutTableHeader* are undefined.

6.4.7 AcpiGetTable

Get a loaded ACPI table.

ACPI_STATUS
 AcpiGetTable (
 ACPI_TABLE_TYPE TableType,
 UINT32 Instance
 ACPI_BUFFER *OutBuffer)

PARAMETERS

TableType One of the defined ACPI table types.

Instance	For table types that support multiple tables, the instance of the table to be returned. For table types that support only a single table, this parameter must be set to one.
OutBuffer	A pointer to location where the table is to be returned.

RETURN VALUE

Status	Exception code that indicates success or reason for failure.
--------	--

EXCEPTIONS

AE_OK	The table was successfully located and returned.
AE_BAD_PARAMETER	At least one of the following is true: <ul style="list-style-type: none"> • The <i>TableType</i> is invalid. • The <i>OutBuffer</i> pointer is NULL. • The <i>Length</i> field of <i>OutBuffer</i> is not ACPI_ALLOCATE_BUFFER, but the <i>Pointer</i> field of <i>OutBuffer</i> is NULL. • The table type only supports single tables, and the <i>Instance</i> is not one.
AE_BUFFER_OVERFLOW	The <i>Length</i> field of <i>OutBuffer</i> indicates that the buffer is too small to hold the table. Upon return, the <i>Length</i> field contains the minimum required buffer length.
AE_NOT_EXIST	There is no table of this type currently loaded, or the table of the specified <i>Instance</i> is not loaded.

Functional Description:

This function obtains an installed ACPI table. The caller supplies an *OutBuffer* large enough to contain the entire ACPI table. The caller should call the *AcpiGetTableHeader* function first to determine the buffer size needed. Upon completion the *Length* field of *OutBuffer* will indicate the number of bytes copied into the *Pointer* field of the *OutBuffer* buffer. This table will be a complete table including the header.

For table types that support more than one table, the *Instance* parameter is used to specify which table of the given type should be returned. For table types that only support single tables, the *Instance* parameter must be set to one.

If the operation fails an appropriate status will be returned and the contents of *OutBuffer* are undefined.

6.5 ACPI Namespace Access

6.5.1 AcpiEvaluateObject

Evaluate an ACPI namespace object and return the result.

ACPI_STATUS

```
AcpiEvaluateObject (
    ACPI_HANDLE      Object,
    ACPI_STRING      *Pathname,
    ACPI_OBJECT_LIST *MethodParams,
    ACPI_BUFFER      *ReturnBuffer)
```

PARAMETERS

Object	One of the following: <ul style="list-style-type: none"> • A handle to the object to be evaluated. • A handle to a parent object that is a prefix to the pathname. • A NULL handle if the pathname is fully qualified.
Pathname	Pathname of namespace object to evaluate. May be either an absolute path or a path relative to the Object.
MethodParams	If the object is a control method, this is a pointer to a list of parameters to pass to the method. This pointer may be NULL if no parameters are being passed to the method or if the object is not a method.
ReturnBuffer	A pointer to a location where the return value of the object evaluation (if any) is placed. If this pointer is NULL, no value is returned.

RETURN VALUE

Status	Exception code that indicates success or reason for failure.
--------	--

EXCEPTIONS

AE_OK	The object was successfully evaluated.
AE_AML_ERROR	An unspecified error occurred during the parsing of the AML code.
AE_AML_PARSE	The control method could not be parsed due to invalid AML code.
AE_AML_BAD_OPCODE	An invalid opcode was encountered in the AML code.
AE_AML_NO_OPERAND	An required operand was missing. This could be caused by a method that does not return any object.

AE_AML_OPERAND_TYPE	An operand object is not of the required ACPI type.
AE_AML_OPERAND_VALUE	An operand object has an invalid value
AE_AML_UNINITIALIZED_LOCAL	A method attempted to access a local variable that was not initialized.
AE_AML_UNINITIALIZED_ARG	A method attempted to access an argument that was not part of the argument list, or was not passed into the method properly.
AE_AML_UNINITIALIZED_ELEMENT	A method attempted to use (dereference) a reference to an element of a package object that is empty (uninitialized).
AE_AML_NUMERIC_OVERFLOW	An overflow occurred during a numeric conversion (Such as BCD conversion.)
AE_AML_REGION_LIMIT	A method attempted to access beyond the end of an Operation Region defined boundary.
AE_AML_BUFFER_LIMIT	A method attempted to access beyond the end of a Buffer object.
AE_AML_PACKAGE_LIMIT	A method attempted to access beyond the end of a Package object.
AE_AML_DIVIDE_BY_ZERO	A method attempted to execute a divide instruction with a zero divisor.
AE_AML_BAD_NAME	A name contained within the AML code has one or more invalid characters.
AE_AML_NAME_NOT_FOUND	A name reference within the AML code could not be found and therefore could not be resolved.
AE_AML_INTERNAL	An error that is internal to the ACPI CA subsystem occurred.
AE_BAD_CHARACTER	An invalid character was found in the Pathname parameter.
AE_BAD_DATA	Bad or invalid data was found in a package object.
AE_BAD_PATHNAME	The path contains at least one ACPI name that is not exactly four characters long.
AE_BAD_PARAMETER	At least one of the following is true: <ul style="list-style-type: none"> • Both the <i>Object</i> and <i>Pathname</i> parameters are NULL. • The <i>Object</i> handle is NULL, but the <i>Pathname</i> is not absolute. • The <i>Pathname</i> is relative but the <i>Object</i> is invalid.

	<ul style="list-style-type: none"> The <i>Length</i> field of <i>OutBuffer</i> is not <code>ACPI_ALLOCATE_BUFFER</code>, but the <i>Pointer</i> field of <i>OutBuffer</i> is <code>NULL</code>.
<code>AE_BUFFER_OVERFLOW</code>	The <i>Length</i> field of the <i>ReturnBuffer</i> is too small to hold the actual returned object. Upon return, the <i>Length</i> field contains the minimum required buffer length.
<code>AE_ERROR</code>	An unspecified error occurred.
<code>AE_NO_MEMORY</code>	Insufficient dynamic memory to complete the request.
<code>AE_NOT_FOUND</code>	The object referenced by the combination of the <i>Object</i> and <i>Pathname</i> was not found within the namespace.
<code>AE_NULL_OBJECT</code>	A required object was missing. This is an internal error.
<code>AE_STACK_OVERFLOW</code>	An internal stack overflow occurred because of an error in the AML, or because control methods or objects are nested too deep.
<code>AE_STACK_UNDERFLOW</code>	An internal stack underflow occurred during evaluation.
<code>AE_TYPE</code>	The object is of a type that cannot be evaluated.

Functional Description:

This function locates and evaluates objects in the namespace. This interface has two modes of operation, depending on the type of object that is being evaluated:

1. If the target object is a control method, the method is executed and the result (if any) is returned.
1. If the target is not a control method, the current “value” of that object is returned. The type of the returned value corresponds to the type of the object; for example, the object (and the corresponding returned result) may be a Integer, a String, or a Buffer.

Specifying a Target Object: The target object may be any valid named ACPI object. To specify the object, a valid *Object*, a valid *Pathname*, or both may be provided. However, at least one of these parameters must be valid.

If the *Object* is `NULL`, the *Pathname* must be a fully qualified (absolute) namespace path.

If the *Object* is non-`NULL`, the *Pathname* may be either:

1. A path relative to the *Object* handle (a *relative* pathname as defined in the ACPI specification)
2. An absolute pathname. In this case, the *Object* handle is ignored.

Parameters to Control Methods: If the object to be evaluated is a control method, the caller can supply zero or more parameters that will be passed to the method when it is executed.. The *MethodParams* parameter is a pointer to an `ACPI_OBJECT_LIST` that in turn is a counted array of `ACPI_OBJECTS`. If *MethodParams* is `NULL`, then no parameters are passed to the control method. If the *Count* field of *MethodParams* is zero, then the entire parameter is treated exactly as if it is a

NULL pointer. If the object to be evaluated is not a control method, the *MethodParams* field is ignored.

Receiving Evaluation Results: The *ReturnObject* parameter optionally receives the results of the object evaluation. If this parameter is NULL, the evaluation results are not returned and are discarded. If there is no result from the evaluation of the object and no error occurred, the *Length* field of the *ReturnObject* parameter is set to zero.

Unsupported Object Types: The object types that cannot be evaluated are the following: ACPI_TYPE_DEVICE. Others TBD.

Exceptional Conditions: Any exceptions that occur during the execution of a control method result in the immediate termination of the control methods. All nested control methods are also terminated, up to and including the parent method.

EXAMPLES

Example 1: Executing the control method with an absolute path, two input parameters, with no return value expected:

```
ACPI_OBJECT_LIST    Params;
ACPI_OBJECT         Obj[2];

/* Initialize the parameter list */

Params.Count = 2;
Params.Pointer = &Obj;

/* Initialize the parameter objects */

Obj[0].Type = ACPI_TYPE_STRING;
Obj[0].String.Pointer = "ACPI User";

Obj[1].Type = ACPI_TYPE_NUMBER;
Obj[1].Number.Value = 0x0E00200A;

/* Execute the control method */

Status = AcpiEvaluateObject (NULL, "\\_SB.PCI0._TWO" , &Params, NULL);
```

Example 2: Before executing a control method that returns a result, we must declare and initialize an ACPI_BUFFER to contain the return value:

```
ACPI_BUFFER         Results;
ACPI_OBJECT         Obj;

/* Initialize the return buffer structure */

Results.Length = sizeof (Obj);
Results.Pointer = &Obj;
```

The three examples that follow are functionally identical.

Example 3: Executing a control method using an absolute path. In this example, there are no input parameters, but a return value is expected.

```
Status = AcpiEvaluateObject (NULL, "\\_SB.PCI0._STA" , NULL, &Results);
```

Example 4: Executing a control method using a relative path. A return value is expected.

```
Status = AcpiPathnameToHandle ("\\_SB.PCI0", &Object)
Status = AcpiEvaluateObject (Object, "_STA" , NULL, &Results);
```

Example 5: Executing a control method using a relative path. A return value is expected.

```
Status = AcpiPathnameToHandle ("\\_SB.PCI0._STA", &Object)
Status = AcpiEvaluateObject (Object, NULL, NULL, &Results);
```

6.5.2 AcpiGetObjectInfo

Get information about an ACPI-related device.

ACPI_STATUS

AcpiGetObjectInfo (
ACPI_HANDLE Object,
ACPI_DEVICE_INFO *OutInfo)

PARAMETERS

Object	A handle to an ACPI object for which information is to be returned.
OutInfo	A pointer to a location where the device info is returned.

RETURN

Status	Exception code that indicates success or reason for failure.
--------	--

EXCEPTIONS

AE_OK	Device info was successfully returned. See the ACPI_DEVICE_INFO structure for valid returned fields.
AE_BAD_PARAMETER	At least one of the following is true: <ul style="list-style-type: none"> • The <i>Object</i> handle is invalid. • The <i>OutInfo</i> pointer is NULL.
AE_TYPE	The Device handle does not refer to an object of type ACPI_TYPE_DEVICE.

Functional Description:

This function obtains information about an object contained within the ACPI namespace. The information returned is a composite of static internal information and the results of evaluating the following standard ACPI device methods and objects on behalf of the device:

- Type — The ACPI object type of the object
- Name — The 4-character ACPI name of the object
- _HID — The hardware ID of the object.
- _UID — The Unique ID of the object.

- _ADR — The address of the object (bus and device specific).
 _STA — The current status of the object/device.

Returned Data Format: The device information is returned in the ACPI_DEVICE_INFO structure that is defined as follows:

```
typedef struct
{
    ACPI_OBJECT_TYPE    Type;
    UINT32              Name;
    UINT32              Valid;
    char                HardwareId [9];
    char                UniqueId [9];
    UINT32              Address;
    UINT32              CurrentStatus;
} ACPI_DEVICE_INFO;
```

Where:

Type	Is the object type code.
Name	The 4-character ACPI name of the object.
Valid	A bit field that indicates which of the remaining fields are valid.
HardwareId	The result of evaluating _HID for this object.
UniqueId	The result of evaluating _UID for this object.
Address	The result of evaluating _ADR for this object.
CurrentStatus	The result of evaluating _STA method for this object.

The fields of the structure that are valid because the corresponding method or object has been successfully found under the device are indicated by the values of the *Valid* bitfield via the following constants:

```
ACPI_VALID_HID
ACPI_VALID_UID
ACPI_VALID_ADR
ACPI_VALID_STA
```

Each bit should be checked before the corresponding value in the structure can be considered valid. **None** of the methods/objects that are used by this interface are *required* by the ACPI specification. Therefore, there is no guarantee that all or even any of them are available for a particular device. Even if none of the methods are found, the interface will return an AE_OK status — but none of the bits set in the *Valid* field return structure will be set.

Both the _HID and _UID values can be of either type STRING or NUMBER in the ACPI tables. In order to provide a consistent data type in the external interface, these values are always returned as NULL terminated strings, regardless of the original data type in the source ACPI table. A data type conversion is performed if necessary.

6.5.3 AcpiGetNextObject

Get a handle to the next child ACPI object of a parent object.

```

ACPI_STATUS
AcpiGetNextObject (
    ACPI_OBJECT_TYPE    Type,
    ACPI_HANDLE         Parent,
    ACPI_HANDLE         Child,
    ACPI_HANDLE         *OutHandle)
    
```

PARAMETERS

Type	The desired type of the next object.
Parent	A handle to a parent object to be searched for the next child object.
Child	A handle to a child object. The next child object of the parent object that matches the Type will be returned. Use the value of NULL to get the first child of the parent.
OutHandle	A pointer to a location where a handle to the next child object is to be returned. If this pointer is NULL, the child object handle is not returned.

RETURN VALUE

Status	Exception code that indicates success or reason for failure.
--------	--

EXCEPTIONS

AE_OK	The next object was successfully found and returned.
AE_BAD_PARAMETER	At least one of the following is true: <ul style="list-style-type: none"> • The <i>Parent</i> handle is invalid. • The <i>Child</i> handle is invalid. • The <i>Type</i> parameter refers to an invalid type
AE_NOT_FOUND	The child object parameter is the last object of the given type within the parent — a next child object was not found. If Child is NULL, this exception means that the parent object has no children.

Functional Description:

This function obtains the next child object of the parent object that is of type *Type*. Both the *Parent* and the *Child* parameters are optional. The behavior for the various combinations of *Parent* and *Child* is as follows:

1. If the *Child* is non-NULL, it is used as the starting point (the *current object*) for the search.

2. If the *Child* is NULL and the *Parent* is non-NULL, the search is performed starting at the beginning of the scope.
3. If both the *Parent* and the *Child* parameters are NULL, the search begins at the start of the namespace (the search begins at the *Root Object*).

If the search fails, an appropriate status will be returned and the value of *OutHandle* is undefined.

This interface is appropriate for use within a loop that looks up a group of objects within the internal namespace. However, the *AcpiWalkNamespace* primitive implements such a loop and may be simpler to use in your application; see the description of this interface for additional details.

6.5.4 AcpiGetParent

Get a handle to the parent object of an ACPI object.

ACPI_STATUS

AcpiGetParent (

ACPI_HANDLE **Child,**
 ACPI_HANDLE ***OutParent)**

PARAMETERS

Child	A handle to an object whose parent is to be returned.
OutParent	A pointer to a location where the handle to the parent object is to be returned.

RETURN VALUE

Status	Exception code that indicates success or reason for failure.
--------	--

EXCEPTIONS

AE_OK	The parent object was successfully found and returned.
AE_BAD_PARAMETER	At least one of the following is true: <ul style="list-style-type: none"> • The <i>Child</i> handle is invalid. • The <i>OutParent</i> pointer is NULL.
AE_NULL_ENTRY	The referenced object has no parent. (Entries at the root level do not have a parent object.)

Functional Description:

This function returns a handle to the parent of the *Child* object. If an error occurs, a status code is returned and the value of *OutParent* is undefined.

6.5.5 AcpiGetType

Get the type of an ACPI object.

```

ACPI_STATUS
AcpiGetType (
    ACPI_HANDLE          Object,
    ACPI_OBJECT_TYPE    *OutType)
    
```

PARAMETERS

Object	A handle to an object whose type is to be returned.
OutType	A pointer to a location where the object type is to be returned.

RETURN

Status	Exception code that indicates success or reason for failure.
--------	--

EXCEPTIONS

AE_OK	The object type was successfully returned.
AE_BAD_PARAMETER	At least one of the following is true: <ul style="list-style-type: none"> • The <i>Object</i> handle is invalid. • The <i>OutType</i> pointer is NULL.

Functional Description:

This function obtains the type of an ACPI namespace object. See the definition of the ACPI_OBJECT_TYPE for a comprehensive listing of the available object types.

6.5.6 AcpiGetHandle

Get the object handle associated with an ACPI name.

```

ACPI_STATUS
AcpiGetHandle (
    ACPI_HANDLE          Parent,
    ACPI_STRING          *Pathname,
    ACPI_HANDLE          *OutHandle)
    
```

PARAMETERS

Parent	A handle to the parent of the object specified by Pathname. In other words, the Pathname is relative to the Parent. If Parent is NULL, the pathname must be a fully qualified pathname.
--------	---

Pathname	A name or pathname to an ACPI object (a NULL terminated ASCII string). The string can be either a single segment ACPI name or a multiple segment ACPI pathname (with path separators).
OutHandle	A pointer to a location where a handle to the object is to be returned.

RETURN VALUE

Status	Exception code that indicates success or reason for failure.
--------	--

EXCEPTIONS

AE_OK	The pathname was successfully associated with an object and the handle was returned.
AE_BAD_CHARACTER	An invalid character was found in the pathname.
AE_BAD_PATHNAME	The path contains at least one ACPI name that is not exactly four characters long.
AE_BAD_PARAMETER	At least one of the following is true: <ul style="list-style-type: none"> • The <i>Pathname</i> pointer is NULL. • The <i>Pathname</i> does not begin with a backslash character. • The <i>OutHandle</i> pointer is NULL.
AE_NO_NAMESPACE	The namespace has not been successfully loaded.
AE_NOT_FOUND	One or more of the segments of the pathname refers to a non-existent object.

Functional Description:

This function translates an ACPI pathname into an object handle. It locates the object in the namespace via the combination of the *Parent* and *Pathname* parameters. Only the specified *Parent* object will be searched for the name — this function will not perform a walk of the namespace tree (See *AcpiWalkNamespace*).

The pathname is relative to the *Parent*. If the parent object is NULL, the *Pathname* must be fully qualified (absolute), meaning that the path to the object must be a complete path from the root of the namespace, and the pathname must begin with a backslash ('\').

Multiple instances of the same name under a given parent (within a given scope) are not allowed by the ACPI specification. However, if more than one instance of a particular name were to appear under a single parent in the ACPI DSDT, only the first one would be successfully loaded into the internal namespace. The second attempt to load the name would collide with the first instance of the name, and the second instance would be ignored.

If the operation fails an appropriate status will be returned and the value of *OutHandle* is undefined.

6.5.7 AcpiGetName

Get the name of an ACPI object.

ACPI_STATUS

AcpiGetName (ACPI_HANDLE UINT32 ACPI_BUFFER	Object, NameType *OutName)
---	---

PARAMETERS

Object	A handle to an object whose name or pathname is to be returned.
NameType	The type of name to return; must be one of these manifest constants: <ul style="list-style-type: none"> • ACPI_FULL_PATHNAME – return a complete pathname (from the namespace root) to the object • ACPI_SINGLE_NAME – return a single segment ACPI name for the object (4 characters, null terminated).
OutName	A pointer to a location where the fully qualified and NULL terminated name or pathname is to be returned.

RETURN VALUE

Status	Exception code that indicates success or reason for failure.
--------	--

EXCEPTIONS

AE_OK	The full pathname associated with the handle was successfully retrieved and returned.
AE_BAD_PARAMETER	At least one of the following is true: <ul style="list-style-type: none"> • The Parent handle is invalid. • The Object handle is invalid. • The OutName pointer is NULL. • The <i>Length</i> field of <i>OutName</i> is not ACPI_ALLOCATE_BUFFER, but the <i>Pointer</i> field of <i>OutName</i> is NULL.
AE_BUFFER_OVERFLOW	The Length field of OutName indicates that the buffer is too small to hold the actual pathname. Upon return, the Length field contains the minimum required buffer length.
AE_NO_NAMESPACE	The namespace has not been successfully loaded.

Functional Description:

This function obtains the name that is associated with the *Object* parameter. The returned name can be either a full pathname (from the root, with path segment separators) or a single segment, 4-character ACPI name. This function and *AcpiGetHandle* are complementary functions, as shown in the examples below.

EXAMPLES

Example 1: The following operations:

```
Status = AcpiGetName (Handle, ACPI_FULL_PATHNAME, &OutName)
Status = AcpiGetHandle (NULL, OutName.BufferPtr, &OutHandle))
```

Yield this result:

```
Handle == OutHandle;
```

Example 2: If Name is a 4-character ACPI name, the following operations:

```
Status = AcpiGetHandle (Parent, Name, &OutHandle))
Status = AcpiGetName (OutHandle, ACPI_SINGLE_NAME, &OutName)
```

Yield this result:

```
Name == OutName.BufferPtr
```

6.5.8 AcpiGetDevices

Walk the ACPI namespace to find objects of type Device.

ACPI_STATUS

AcpiGetDevices (

char	*HID,
ACPI_WALK_CALLBACK	UserFunction,
void	*UserContext,
void	**ReturnValue)

PARAMETERS

HID	A device Hardware ID to search for. If NULL, all objects of type Device are passed to the UserFunction.
UseFunction	A pointer to a function that is called when the namespace object is deleted:
UserContext	A value that will be passed as a parameter to the user function each time it is invoked.
ReturnValue	A pointer to a location where the (void *) return value from the UserFunction is to be placed if the walk was terminated early. Otherwise, NULL is returned.

RETURN VALUE

Status Exception code that indicates success or reason for failure.

EXCEPTIONS

AE_OK The walk was successful. Termination occurred from completion of the walk or by the user function, depending on the value of the return parameter.

AE_BAD_PARAMETER The *UserFunction* address is NULL.

Functional Description:

This function performs a modified depth-first walk of the namespace tree. The *UserFunction* is invoked whenever an object of type Device with a matching HID is found. If the user function returns a non-zero value, the search is terminated immediately and this value is returned to the caller.

If HID is NULL, all objects of type Device within the namespace are passed to the User Function.

6.5.9 AcpiAttachData

Attach user data to an ACPI namespace object.

ACPI_STATUS

AcpiAttachData (
ACPI_HANDLE Object,
ACPI_OBJECT_HANDLER Handler
void *Data)

PARAMETERS

Object A handle to an object to which the data will be attached.

Handler A pointer to a function that is called when the namespace object is deleted:

Data A pointer to arbitrary user data. The pointer is stored in the namespace with the namespace object.

RETURN VALUE

Status Exception code that indicates success or reason for failure.

EXCEPTIONS

AE_OK The data was successfully attached.

AE_BAD_PARAMETER At least one of the following is true:

- The Object handle is invalid.
- The *Handler* pointer is NULL.

- The *Data* pointer is NULL.

AE_NO_MEMORY

AE_NO_NAMESPACE The namespace has not been successfully loaded.

Functional Description:

This function allows arbitrary data to be associated with a namespace object.

6.5.10 AcpiDetachData

Remove a data attachment to a namespace object.
--

ACPI_STATUS

AcpiAttachData (
 ACPI_HANDLE Object,
 ACPI_OBJECT_HANDLER Handler)

PARAMETERS

Object	A handle to an object to which the data will be attached.
Handler	A pointer to a function that is called when the namespace object is deleted. This must be the same pointer used when the original call to <i>AcpiAttachData</i> was used.

RETURN VALUE

Status	Exception code that indicates success or reason for failure.
--------	--

EXCEPTIONS

AE_OK	The data was successfully detached.
AE_BAD_PARAMETER	At least one of the following is true: <ul style="list-style-type: none"> • The Object handle is invalid. • The <i>Handler</i> pointer is NULL.
AE_NO_MEMORY	
AE_NO_NAMESPACE	The namespace has not been successfully loaded.

Functional Description:

This function removes a previous association between user data and a namespace object.

6.5.11 AcpiGetData

Retrieve data that was associated with a namespace object.

ACPI_STATUS

```
AcpiGetData (
    ACPI_HANDLE      Object,
    ACPI_OBJECT_HANDLER Handler,
    void             **Data)
```

PARAMETERS

Object	A handle to an object to from which the attached data will be returned.
Handler	A pointer to a function that is called when the namespace object is deleted: This must be the same pointer used when the original call to <i>AcpiAttachData</i> was used.
Data	A pointer to where the arbitrary user data pointer will be returned. The pointer is stored in the namespace with the namespace object.

RETURN VALUE

Status	Exception code that indicates success or reason for failure.
--------	--

EXCEPTIONS

AE_OK	The data was successfully returned.
AE_BAD_PARAMETER	At least one of the following is true: <ul style="list-style-type: none"> • The Object handle is invalid. • The <i>Handler</i> pointer is NULL. • The <i>Data</i> pointer is NULL.
AE_NO_MEMORY	
AE_NO_NAMESPACE	The namespace has not been successfully loaded.

Functional Description:

This function retrieves data that was previously associated with a namespace object.

6.5.12 AcpiWalkNamespace

Traverse a portion of the ACPI namespace to find objects of a given type.

```

ACPI_STATUS
AcpiWalkNamespace (
    ACPI_OBJECT_TYPE    Type,
    ACPI_HANDLE         StartObject,
    UINT32              MaxDepth,
    ACPI_WALK_CALLBACK  UserFunction,
    void                *UserContext,
    void                **ReturnValue)
  
```

PARAMETERS

Type	The type of object desired.
StartObject	A handle to an object where the namespace walk is to begin. The constant ACPI_ROOT_OBJECT indicates to start the walk at the root of the namespace (walk the entire namespace.)
MaxDepth	The maximum number of levels to descend in the namespace during the walk.
UserFunction	A pointer to a user-written function that is invoked for each matching object that is found during the walk. (See the interface specification for the user function below.)
UserContext	A value that will be passed as a parameter to the user function each time it is invoked.
ReturnValue	A pointer to a location where the (void *) return value from the UserFunction is to be placed if the walk was terminated early. Otherwise, NULL is returned.

RETURN VALUE

Status	Exception code that indicates success or reason for failure.
--------	--

EXCEPTIONS

AE_OK	The walk was successful. Termination occurred from completion of the walk or by the user function, depending on the value of the return parameter.
AE_BAD_PARAMETER	At least one of the following is true: <ul style="list-style-type: none"> • The <i>MaxDepth</i> is zero. • The <i>UserFunction</i> address is NULL. • The <i>StartObject</i> handle is invalid. • The <i>Type</i> is invalid.

Functional Description:

This function performs a modified depth-first walk of the namespace tree, starting (and ending) at the object specified by the *StartObject* handle. The *UserFunction* is invoked whenever an object that matches the type parameter is found. If the user function returns a non-zero value, the search is terminated immediately and this value is returned to the caller.

The point of this procedure is to provide a generic namespace walk routine that can be called from multiple places to provide multiple services; the user function can be tailored to each task — whether it is a print function, a compare function, etc.

6.5.12.1 Interface to User Callback Function

Interface to the user function that is invoked from AcpiWalkNamespace.

```

ACPI_STATUS (*ACPI_WALK_CALLBACK) (
    ACPI_HANDLE      ObjHandle,
    UINT32           NestingLevel,
    void             *Context,
    void             **ReturnValue)
    
```

PARAMETERS

ObjHandle	A handle to an object that matches the search criteria.
Nesting Level	Depth of this object within the namespace (distance from the root)
Context	The UserContext value that was passed as a parameter to the AcpiWalkNamespace function.
ReturnValue	A pointer to a location where the return value (if any) from the user function is to be stored.

RETURN VALUE

Status	AE_OK	Continue the walk
	AE_TERMINATE	Stop the walk immediately
	AE_DEPTH	Go no deeper into the namespace tree
	All others	Abort the walk with this exception code

Functional Description:

This function is called from *AcpiWalkNamespace* whenever a object of the desired type is found. The walk can be modified by the exception code returned from this function. AE_TERMINATE will abort the walk immediately, and *AcpiWalkNamespace* will return AE_OK to the original caller. AE_DEPTH will prevent the walk from progressing any deeper down the current branch of the namespace tree. AE_OK is the normal return that allows the walk to continue normally. All other exception codes will cause the walk to terminate and the exception is returned to the original caller of *AcpiWalkNamespace*.

6.6 ACPI Resource Management

6.6.1 AcpiGetCurrentResources

Get the current resource list associated with an ACPI-related device.

ACPI_STATUS

AcpiGetCurrentResources (

ACPI_HANDLE

ACPI_BUFFER

Device,
*OutBuffer)

PARAMETERS

Device	A handle to a device object for which the current resources are to be returned.
OutBuffer	A pointer to a location where the current resource list is to be returned.

RETURN VALUE

Status	Exception code that indicates success or reason for failure.
--------	--

EXCEPTIONS

AE_OK	The resource list was successfully returned.
AE_BAD_PARAMETER	At least one of the following is true: <ul style="list-style-type: none"> The <i>Device</i> handle is invalid. The <i>OutBuffer</i> pointer is NULL. The <i>Length</i> field of <i>OutBuffer</i> is not ACPI_ALLOCATE_BUFFER, but the <i>Pointer</i> field of <i>OutBuffer</i> is NULL.
AE_BUFFER_OVERFLOW	The <i>Length</i> field of <i>OutBuffer</i> indicates that the buffer is too small to hold the resource list. Upon return, the <i>Length</i> field contains the minimum required buffer length.
AE_TYPE	The <i>Device</i> handle refers to an object that is not of type ACPI_TYPE_DEVICE.

Functional Description:

This function obtains the current resources for a specific device. The caller must first acquire a handle for the desired device. The resource data is placed in the buffer pointed contained in the *OutBuffer* structure. Upon completion the *Length* field of *OutBuffer* will indicate the number of bytes copied into the *Pointer* field of the *OutBuffer* buffer. This routine will never return a partial resource structure.

If the function fails an appropriate status will be returned and the value of *OutBuffer* is undefined.

6.6.2 AcpiGetPossibleResources

Get the possible resource list associated with an ACPI-related device.

ACPI_STATUS

AcpiGetPossibleResources (
 ACPI_HANDLE **Device,**
 ACPI_BUFFER ***OutBuffer)**

PARAMETERS

Device	A handle to a device object for which the possible resources are to be returned.
OutBuffer	A pointer to a location where the possible resource list is to be returned.

RETURN VALUE

Status	Exception code that indicates success or reason for failure.
--------	--

EXCEPTIONS

AE_OK	The resource list was successfully returned.
AE_BAD_PARAMETER	At least one of the following is true: <ul style="list-style-type: none"> • The <i>Device</i> handle is invalid. • The <i>OutBuffer</i> pointer is NULL. • The <i>Length</i> field of <i>OutBuffer</i> is not ACPI_ALLOCATE_BUFFER, but the <i>Pointer</i> field of <i>OutBuffer</i> is NULL.
AE_BUFFER_OVERFLOW	The <i>Length</i> field of <i>OutBuffer</i> indicates that the buffer is too small to hold the resource table. Upon return, the <i>Length</i> field contains the minimum required buffer length.
AE_TYPE	The <i>Device</i> handle refers to an object that is not of type ACPI_TYPE_DEVICE.

Functional Description:

This function obtains the list of the possible resources for a specific device. The caller must first acquire a handle for the desired device. The resource data is placed in the buffer contained in the *OutBuffer* structure. Upon completion the *Length* field of *OutBuffer* will indicate the number of bytes copied into the *Pointer* field of the *OutBuffer* buffer. This routine will never return a partial resource structure.

If the function fails an appropriate status will be returned and the value of *OutBuffer* is undefined.

6.6.3 AcpiSetCurrentResources

Set the current resource list associated with an ACPI-related device.

ACPI_STATUS

AcpiSetCurrentResources (

ACPI_HANDLE

Device,

ACPI_BUFFER

*InBuffer)

PARAMETERS

Device

A handle to a device object for which the current resource list is to be set.

InBuffer

A pointer to an ACPI_BUFFER containing the resources to be set for the device.

RETURN VALUE

Status

Exception code that indicates success or reason for failure.

EXCEPTIONS

AE_OK

The resources were set successfully.

AE_BAD_PARAMETER

At least one of the following is true:

- The *Device* handle is invalid.
- The *InBuffer* pointer is NULL.
- The *Pointer* field of *InBuffer* is NULL.
- The *Length* field of *InBuffer* is zero.

AE_TYPE

The Device handle refers to an object that is not of type ACPI_TYPE_DEVICE.

Functional Description:

This function sets the current resources for a specific device. The caller must first acquire a handle for the desired device. The resource data is passed to the routine the buffer pointed to by the *InBuffer* variable.

6.6.4 AcpiGetIRQRoutingTable

Get the ACPI Interrupt Request (IRQ) Routing Table for an ACPI-related device.

ACPI_STATUS
AcpiGetIRQRoutingTable (
 ACPI_HANDLE
 ACPI_BUFFER

Device,
***OutBuffer)**

PARAMETERS

Device	A handle to a device object for which the IRQ routing table is to be returned.
OutBuffer	A pointer to a location where the IRQ routing table is to be returned.

RETURN VALUE

Status	Exception code that indicates success or reason for failure.
--------	--

EXCEPTIONS

AE_OK	The system information list was successfully returned.
AE_BAD_PARAMETER	At least one of the following is true: <ul style="list-style-type: none"> • The Device handle is invalid. • The OutBuffer pointer is NULL. • The <i>Length</i> field of <i>OutBuffer</i> is not ACPI_ALLOCATE_BUFFER, but the <i>Pointer</i> field of <i>OutBuffer</i> is NULL.
AE_BUFFER_OVERFLOW	The Length field of OutBuffer indicates that the buffer is too small to hold the IRQ table. Upon return, the Length field contains the minimum required buffer length.
AE_TYPE	The Device handle refers to an object that is not of type ACPI_TYPE_DEVICE.

Functional Description:

This function obtains the IRQ routing table for a specific bus. It does so by attempting to execute the `_PRT` method contained in the scope of the device whose handle is passed as a parameter.

If the function fails an appropriate status will be returned and the value of *OutBuffer* is undefined.

6.6.5 AcpiWalkResources

Parse an ACPI Resource List.

```

ACPI_STATUS
AcpiWalkResources (
    ACPI_HANDLE
    char
    ACPI_WALK_RESOURCE_CALLBACK
    void
    DeviceHandle,
    *Path,
    UserFunction,
    *UserContext)

```

PARAMETERS

DeviceHandle	A handle to the Device for which one of the resource lists will be walked:
Path	Path to a resource method (path to either a _CRS or _PRS method.)
UserFunction	A pointer to a user-written function that is invoked for each resource object within the resource list. (See the interface specification for the user function below.)
UserContext	A value that will be passed as a parameter to the user function each time it is invoked.

RETURN VALUE

Status	Exception code that indicates success or reason for failure.
--------	--

EXCEPTIONS

AE_OK	The event was successfully enabled.
AE_BAD_PARAMETER	The <i>DeviceHandle</i> is invalid or the <i>Path</i> does not refer to a _CRS or _PRS control method.

Functional Description:

This function retrieves the current or possible resource list for the specified device. The User Function is called once for each resource in the list – freeing the caller from having to parse the list itself.

6.6.5.1 Interface to User Callback Function

Interface to the user function that is invoked from *AcpiWalkResources*.

```
ACPI_STATUS (*ACPI_WALK_RESOURCE_CALLBACK) (
    ACPI_RESOURCE *Resource,
    void *Context)
```

PARAMETERS

Resource	A pointer to a single resource within the resource list.
Context	The UserContext value that was passed as a parameter to the <i>AcpiWalkResources</i> function.

RETURN VALUE

Status	AE_OK	Continue the walk
	AE_TERMINATE	Stop the walk immediately
	AE_DEPTH	Go no deeper into the namespace tree
	All others	Abort the walk with this exception code

Functional Description:

This function is called from *AcpiWalkResource* for each resource object in the resource list.

6.7 ACPI Fixed Event Management

6.7.1 AcpiEnableEvent

Enable an ACPI Fixed Event.

ACPI_STATUS
AcpiEnableEvent (

UINT32	Event,
UINT32	Flags)

PARAMETERS

Event	The fixed event to be enabled. This parameter must be one of the following manifest constants:
-------	--

ACPI_EVENT_PMTIMER

ACPI_EVENT_GLOBAL

ACPI_EVENT_POWER_BUTTON

ACPI_EVENT_SLEEP_BUTTON

ACPI_EVENT_RTC

Flags	Reserved, set to zero.
-------	------------------------

RETURN VALUE

Status	Exception code that indicates success or reason for failure.
--------	--

EXCEPTIONS

AE_OK	The event was successfully enabled.
-------	-------------------------------------

AE_BAD_PARAMETER	The <i>Event</i> is invalid.
------------------	------------------------------

Functional Description:

This function enables a single ACPI fixed event.

6.7.2 AcpiDisableEvent

Disable an ACPI Fixed Event.

ACPI_STATUS
AcpiDisableEvent (
 UINT32 **Event,**
 UINT32 **Flags)**

PARAMETERS

Event The fixed event to be disabled. This parameter must be one of the following manifest constants:

- ACPI_EVENT_PMTIMER
- ACPI_EVENT_GLOBAL
- ACPI_EVENT_POWER_BUTTON
- ACPI_EVENT_SLEEP_BUTTON
- ACPI_EVENT_RTC

Flags Reserved, set to zero.

RETURN VALUE

Status Exception code that indicates success or reason for failure.

EXCEPTIONS

- AE_OK The event was successfully disabled.
- AE_BAD_PARAMETER The *Event* is invalid.

Functional Description:

This function disables a single ACPI fixed event.

6.7.3 AcpiClearEvent

Clear a pending ACPI Fixed Event.

ACPI_STATUS
AcpiClearEvent (
 UINT32 **Event)**

PARAMETERS

Event The fixed event to be cleared. This parameter must be one of the following manifest constants:

ACPI_EVENT_PMTIMER
 ACPI_EVENT_GLOBAL
 ACPI_EVENT_POWER_BUTTON
 ACPI_EVENT_SLEEP_BUTTON
 ACPI_EVENT_RTC

RETURN VALUE

Status Exception code that indicates success or reason for failure.

EXCEPTIONS

AE_OK The event was successfully cleared.
 AE_BAD_PARAMETER The *Event* is invalid.

Functional Description:

This function clears (zeros the status bit for) a single ACPI fixed event.

6.7.4 AcpiGetEventStatus

Obtain the status of an ACPI Fixed Event.

ACPI_STATUS

AcpiGetEventStatus (
 UINT32 **Event,**
 ACPI_EVENT_STATUS ***EventStatus)**

PARAMETERS

Event The fixed event for which status will be obtained. This parameter must be one of the following manifest constants:

ACPI_EVENT_PMTIMER
 ACPI_EVENT_GLOBAL
 ACPI_EVENT_POWER_BUTTON
 ACPI_EVENT_SLEEP_BUTTON
 ACPI_EVENT_RTC

EventStatus Where the event status is returned. The following bits may be set:

ACPI_EVENT_FLAG_SET

RETURN VALUE

Status	Exception code that indicates success or reason for failure.
--------	--

EXCEPTIONS

AE_OK	The event was successfully disabled.
AE_BAD_PARAMETER	At least one of the following is true: <ul style="list-style-type: none"> • The <i>Event</i> is invalid. • The <i>EventStatus</i> pointer is NULL or invalid

Functional Description:

This function obtains the current status of a single ACPI fixed event.

6.7.5 AcpInstallFixedEventHandler

Install a handler for ACPI Fixed Events.
ACPI_STATUS

AcpInstallFixedEventHandler (
ACPI_EVENT_TYPE	Event,
ACPI_EVENT_HANDLER	Handler,
void	*Context)

PARAMETERS

Event	The fixed event to be managed by this handler.
Handler	Address of the handler to be installed.
Context	A context value that will be passed to the handler as a parameter.

RETURN VALUE

Status	Exception code that indicates success or reason for failure.
--------	--

EXCEPTIONS

AE_OK	The handler was successfully installed.
AE_BAD_PARAMETER	At least one of the following is true: <ul style="list-style-type: none"> • The <i>Event</i> is invalid. • The <i>Handler</i> pointer is NULL.
AE_ERROR	The fixed event enable register could not be written.
AE_EXIST	A handler for this event is already installed.

Functional Description:

This function installs a handler for a predefined fixed event.

6.7.5.1 Interface to Fixed Event Handlers

Definition of the handler interface for Fixed Events.

```
typedef
UINT32 (*ACPI_EVENT_HANDLER) (
    void                *Context)
```

PARAMETERS

Context	The Context value that was passed as a parameter to the <i>AcpiInstallFixedEventHandler</i> function.
---------	---

RETURN VALUE

???	TBD.
-----	------

Functional Description:

This handler is installed via *AcpiInstallFixedEventHandler*. It is called whenever the particular fixed event it was installed to handle occurs.

This function executes in the context of an interrupt handler.

6.7.6 AcpiRemoveFixedEventHandler

Remove an ACPI Fixed Event handler.

```
ACPI_STATUS
AcpiRemoveFixedEventHandler (
    ACPI_EVENT_TYPE      Event,
    ACPI_EVENT_HANDLER   Handler)
```

PARAMETERS

Event	The fixed event whose handler is to be removed.
Handler	Address of the previously installed handler.

RETURN VALUE

Status	Exception code that indicates success or reason for failure.
--------	--

EXCEPTIONS

AE_OK	The handler was successfully removed.
-------	---------------------------------------

AE_BAD_PARAMETER

At least one of the following is true:

- The *Event* is invalid.
- The *Handler* pointer is NULL.
- The *Handler* address is not the same as the one that is installed.

AE_ERROR

The fixed event enable register could not be written.

AE_NOT_EXIST

There is no handler installed for this event.

Functional Description:

This function removes a handler for a predefined fixed event that was previously installed via a call to *AcpiInstallFixedEventHandler*.

6.8 ACPI General Purpose Event Management

6.8.1 AcpInstallGpeBlock

Install a GPE Block Device.

ACPI_STATUS

AcpInstallGpeBlock (

ACPI_HANDLE	GpeDevice,
ACPI_GENERIC_ADDRESS	*GpeBlockAddress,
UINT32	RegisterCount,
UINT32	InterruptLevel)

PARAMETERS

GpeDevice	A handle for the GPE Block Device to be installed.
GpeNumber	The GPE number to be enabled within the specified GPE Block. Named GPE Block Devices always begin at zero.
RegisterCount	The number of status/enable GPE register pairs in this block.
InterruptLevel	The hardware interrupt level that this GPE block is to be associated with. Can be SCI_INT or any other system interrupt level.

RETURN VALUE

Status	Exception code that indicates success or reason for failure.
--------	--

EXCEPTIONS

AE_OK	The GPE was successfully enabled.
AE_BAD_PARAMETER	At least one of the following is true: <ul style="list-style-type: none"> The <i>GpeDevice</i> is invalid or does not refer to a valid GPE Block Device. The <i>GpeNumber</i> is out of range for the referenced <i>GpeDevice</i>.

Functional Description:

This function installs a GPE Block Device. It is intended for use by a device driver that supports the enumeration of GPE Block Devices. The caller must identify each Block Device in the ACPI namespace (each has a `_HID` of `ACPI0006`) and obtain the resource requirements (`_CRS`, etc.) and make this call for each device found.

Gpe Block Device handling is supported in the ACPI CA core subsystem because the `SCI_INT` is owned by the core subsystem, and the FADT-defined GPE blocks are also owned by the core. Via

this interface, the core also supports GPE Block Devices and the associated interrupts, detection, dispatch, and GPE control method execution — thus centralizing all GPE support to the core.

6.8.2 AcpiRemoveGpeBlock

Remove a GPE Block Device.

ACPI_STATUS

AcpiRemoveGpeBlock (
ACPI_HANDLE **GpeDevice)**

PARAMETERS

GpeDevice A handle for the GPE Block Device to be removed.

RETURN VALUE

Status Exception code that indicates success or reason for failure.

EXCEPTIONS

AE_OK The GPE was successfully enabled.

AE_BAD_PARAMETER At least one of the following is true:

- The *GpeDevice* is invalid or does not refer to a valid GPE Block Device.
- The *GpeNumber* is out of range for the referenced *GpeDevice*.

Functional Description:

This function removed a GPE Block Device that was previously installed via *AcpiInstallGpeBlock*.

6.8.3 AcpiEnableGpe

Enable an ACPI General Purpose Event.

ACPI_STATUS

AcpiEnableGpe (
ACPI_HANDLE **GpeDevice,**
UINT32 **GpeNumber,**
UINT32 **Flags)**

PARAMETERS

GpeDevice A handle for the parent GPE Block Device of the GPE to be enabled. Specify a NULL handle to indicate that the permanent GPE blocks defined in the FADT (GPE0 and GPE1) are to be used.

GpeNumber	The GPE number to be enabled within the specified GPE Block. The GPE0 block always begins at zero. GPE1 begins at GPE1_BASE (in the FADT). Named GPE Block Devices always begin at zero.
Flags	<p>ACPI_EVENT_WAKE_ENABLE – This GPE should also be enabled for wake events.</p> <p>ACPI_NOT_ISR – Caller is not executing from an Interrupt Service Routine (interrupt level.)</p>

RETURN VALUE

Status	Exception code that indicates success or reason for failure.
--------	--

EXCEPTIONS

AE_OK	The GPE was successfully enabled.
AE_BAD_PARAMETER	At least one of the following is true: <ul style="list-style-type: none"> The <i>GpeDevice</i> is invalid or does not refer to a valid GPE Block Device. The <i>GpeNumber</i> is out of range for the referenced <i>GpeDevice</i>.

Functional Description:

This function enables a single General Purpose Event. Both the FADT-defined GPE blocks and GPE Block Devices are supported. The GPE blocks defined in the FADT are permanent and installed during system initialization. These permanent blocks, GPE0 and GPE1, are treated as a single logical block differentiated by non-overlapping GPE numbers. GPE Block Devices are installed via *AcpiInstallGpeBlock* during bus/device enumeration.

This function may be called from an interrupt service routine (typically a GPE handler) or a device driver, depending on the setting of the *Flags* parameter.

6.8.4 AcpiClearGpe

Clear a pending ACPI General Purpose Event.

ACPI_STATUS

AcpiClearGpe (

ACPI_HANDLE
 UINT32
 UINT32

GpeDevice,
 GpeNumber,
 Flags)

PARAMETERS

GpeDevice	A handle for the parent GPE Block Device of the GPE to be cleared. Specify a NULL handle to indicate that the permanent GPE blocks defined in the FADT (GPE0 and GPE1) are to be used.
-----------	--

GpeNumber	The GPE number to be cleared within the specified GPE Block. The GPE0 block always begins at zero. GPE1 begins at GPE1_BASE (in the FADT). Named GPE Block Devices always begin at zero.
Flags	ACPI_NOT_ISR – Caller is not executing from an Interrupt Service Routine (interrupt level.)

RETURN VALUE

Status	Exception code that indicates success or reason for failure.
--------	--

EXCEPTIONS

AE_OK	The GPE was successfully cleared.
AE_BAD_PARAMETER	At least one of the following is true: <ul style="list-style-type: none"> • The <i>GpeDevice</i> is invalid or does not refer to a valid GPE Block Device. • The <i>GpeNumber</i> is out of range for the referenced <i>GpeDevice</i>.

Functional Description:

This function clears a single General Purpose Event. Both the FADT-defined GPE blocks and GPE Block Devices are supported. The GPE blocks defined in the FADT are permanent and installed during system initialization. These permanent blocks, GPE0 and GPE1, are treated as a single logical block differentiated by non-overlapping GPE numbers. GPE Block Devices are installed via *AcpiInstallGpeBlock* during bus/device enumeration.

This function may be called from an interrupt service routine (typically a GPE handler) or a device driver, depending on the setting of the *Flags* parameter.

6.8.5 AcpiGetGpeStatus

Obtain the status of an ACPI General Purpose Event.

ACPI_STATUS
AcpiGetGpeStatus (
 ACPI_HANDLE **GpeDevice,**
 UINT32 **GpeNumber,**
 UINT32 **Flags,**
 ACPI_EVENT_STATUS ***EventStatus)**

PARAMETERS

GpeDevice	A handle for the parent GPE Block Device of the GPE for which status is to be obtained. Specify a NULL handle to indicate that the permanent GPE blocks defined in the FADT (GPE0 and GPE1) are to be used.
-----------	---

GpeNumber	The GPE number to be enabled within the specified GPE Block. The GPE0 block always begins at zero. GPE1 begins at GPE1_BASE (in the FADT). Named GPE Block Devices always begin at zero.
Flags	ACPI_NOT_ISR – Caller is not executing from an Interrupt Service Routine (interrupt level.)
EventStatus	Where the event status is returned. The following bits may be set:

ACPI_EVENT_FLAG_SET

RETURN VALUE

Status	Exception code that indicates success or reason for failure.
--------	--

EXCEPTIONS

AE_OK	The GPE was successfully enabled.
AE_BAD_PARAMETER	At least one of the following is true: <ul style="list-style-type: none"> The <i>GpeDevice</i> is invalid or does not refer to a valid GPE Block Device. The <i>GpeNumber</i> is out of range for the referenced <i>GpeDevice</i>.

Functional Description:

This function obtains the status of a single General Purpose Event. Both the FADT-defined GPE blocks and GPE Block Devices are supported. The GPE blocks defined in the FADT are permanent and installed during system initialization. These permanent blocks, GPE0 and GPE1, are treated as a single logical block differentiated by non-overlapping GPE numbers. GPE Block Devices are installed via *AcpiInstallGpeBlock* during bus/device enumeration.

This function may be called from an interrupt service routine (typically a GPE handler) or a device driver, depending on the setting of the *Flags* parameter.

6.8.6 AcpiDisableGpe

Disable an ACPI General Purpose Event.

ACPI_STATUS

AcpiDisableGpe (
ACPI_HANDLE
UINT32
UINT32

GpeDevice,
GpeNumber,
Flags)

PARAMETERS

GpeDevice	A handle for the parent GPE Block Device of the GPE to be disabled. Specify a NULL handle to indicate that the
-----------	--



permanent GPE blocks defined in the FADT (GPE0 and GPE1) are to be used.

GpeNumber	The GPE number to be disabled within the specified GPE Block. The GPE0 block always begins at zero. GPE1 begins at GPE1_BASE (in the FADT). Named GPE Block Devices always begin at zero.
Flags	ACPI_EVENT_WAKE_DISABLE – This GPE should also be disabled for wake events. ACPI_NOT_ISR – Caller is not executing from an Interrupt Service Routine (interrupt level.)

RETURN VALUE

Status	Exception code that indicates success or reason for failure.
--------	--

EXCEPTIONS

AE_OK	The GPE was successfully disabled.
AE_BAD_PARAMETER	At least one of the following is true: <ul style="list-style-type: none">• The <i>GpeDevice</i> is invalid or does not refer to a valid GPE Block Device.• The <i>GpeNumber</i> is out of range for the referenced <i>GpeDevice</i>.

Functional Description:

This function disables a single General Purpose Event. Both the FADT-defined GPE blocks and GPE Block Devices are supported. The GPE blocks defined in the FADT are permanent and installed during system initialization. These permanent blocks, GPE0 and GPE1, are treated as a single logical block differentiated by non-overlapping GPE numbers. GPE Block Devices are installed via *AcpiInstallGpeBlock* during bus/device enumeration.

This function may be called from an interrupt service routine (typically a GPE handler) or a device driver, depending on the setting of the *Flags* parameter.

6.8.7 AcpiInstallGpeHandler

Install a handler for ACPI General Purpose Events.

```

ACPI_STATUS
AcpiInstallGpeHandler (
    ACPI_HANDLE          GpeDevice,
    UINT32               GpeNumber,
    ACPI_GPE_HANDLER    Handler,
    void                 *Context)

```

PARAMETERS

GpeDevice	A handle for the parent GPE Block Device of the GPE for which the handler is to be installed. Specify a NULL handle to indicate that the permanent GPE blocks defined in the FADT (GPE0 and GPE1) are to be used.
GpeNumber	A zero based GPE number. GPE numbers start with GPE register bank zero, and continue sequentially through GPE bank one.
Handler	Address of the handler to be installed.
Context	A context value that will be passed to the handler as a parameter.

RETURN VALUE

Status	Exception code that indicates success or reason for failure.
--------	--

EXCEPTIONS

AE_OK	The handler was successfully installed.
AE_BAD_PARAMETER	At least one of the following is true: <ul style="list-style-type: none"> The <i>GpeNumber</i> is invalid. The <i>Handler</i> pointer is NULL.
AE_EXIST	A handler for this general-purpose event is already installed.

Functional Description:

This function installs a handler for a general-purpose event

EXCEPTIONS

AE_OK	The handler was successfully removed.
AE_BAD_PARAMETER	At least one of the following is true: <ul style="list-style-type: none">• The <i>GpeNumber</i> is invalid.• The <i>Handler</i> pointer is NULL.• The <i>Handler</i> address is not the same as the one that is installed
AE_NOT_EXIST	There is no handler installed for this general-purpose event.

Functional Description:

This function removes a handler for a general-purpose event that was previously installed via a call to *AcpiInstallGpeHandler*.

6.9 ACPI Miscellaneous Handler Support

6.9.1 AcpiInstallNotifyHandler

Install a handler for notification events on an ACPI object.

ACPI_STATUS

```

AcpiInstallNotifyHandler (
    ACPI_HANDLE          Object,
    UINT32              Type,
    ACPI_NOTIFY_HANDLER Handler,
    void                *Context)
    
```

PARAMETERS

Object Handle to the object for which notify events will be handled. Notices on this object will be dispatched to the handler. If **ACPI_ROOT_OBJECT** is specified, the handler will become a global handler that receives all (system wide) notifications of the **Type** specified. Otherwise, this object must be one of the following types:

- ACPI_TYPE_DEVICE**
- ACPI_TYPE_PROCESSOR**
- ACPI_TYPE_POWER**
- ACPI_TYPE_THERMAL**

Type Specifies the type of notifications that are to be received by this handler:

- ACPI_SYSTEM_NOTIFY** – Notifications 0x00 to 0x7F
- ACPI_DEVICE_NOTIFY** – Notifications 0x80 to 0xFF

Handler Address of the handler to be installed.

Context A context value that will be passed to the handler as a parameter.

RETURN VALUE

Status Exception code that indicates success or reason for failure.

EXCEPTIONS

AE_OK The handler was successfully installed.

AE_BAD_PARAMETER	At least one of the following is true: <ul style="list-style-type: none"> • The <i>Object</i> handle is invalid. • The <i>Type</i> is not a valid value. • The <i>Handler</i> pointer is NULL.
AE_EXIST	A handler for notifications on this object is already installed.
AE_TYPE	The type of the Object is not one of the supported object types.

Functional Description:

This function installs a handler for notify events on an ACPI object. According to the ACPI specification, the only objects that can receive notifications are Devices and Thermal Zones.

A global handler for each notify type may be installed by using the `ACPI_ROOT_OBJECT` constant as the object handle. When a notification is received, it is first dispatched to the global handler (if there is one), and then to the device-specific notify handler (if there is one)

6.9.1.1 Interface to Notification Event Handlers

Definition of the handler interface for Notification Events.

```
typedef
void (*ACPI_NOTIFY_HANDLER) (
    ACPI_HANDLE      Device
    UINT32           Value,
    void             *Context)
```

PARAMETERS

Device	The handle for the device on which the notify occurred.
Value	The notify value that was passed as a parameter to the AML notify operation.
Context	The Context value that was passed as a parameter to the <code>AcpiInstallNotifyHandler</code> function.

RETURN VALUE

None

Functional Description:

This handler is installed via `AcpiInstallNotifyHandler`. It is called whenever a **notify** occurs on the target object. If the handler is installed as a global notification handler, it is called for every notify of the type specified when it was installed.

This function **does not** execute in the context of an interrupt handler.

6.9.2 AcpiRemoveNotifyHandler

Remove a handler for ACPI notification events.

ACPI_STATUS
AcpiRemoveNotifyHandler (
 ACPI_HANDLE **Object,**
 UINT32 **Type,**
 ACPI_NOTIFY_HANDLER **Handler)**

PARAMETERS

Object	Handle to the object for which a notify handler will be removed. If ACPI_ROOT_OBJECT is specified, the global handler of the Type specified is removed. Otherwise, this object must be one of the following types:
--------	--

ACPI_TYPE_DEVICE
 ACPI_TYPE_PROCESSOR
 ACPI_TYPE_POWER
 ACPI_TYPE_THERMAL

HandlerType	Specifies the type of notify handler to be removed:
-------------	---

ACPI_SYSTEM_NOTIFY – Notifications 0x00 to 0x7F
 ACPI_DEVICE_NOTIFY – Notifications 0x80 to 0xFF

Handler	Address of the previously installed handler.
---------	--

RETURN VALUE

Status	Exception code that indicates success or reason for failure.
--------	--

EXCEPTIONS

AE_OK	The handler was successfully removed.
AE_BAD_PARAMETER	At least one of the following is true: <ul style="list-style-type: none"> • The Object handle is invalid. • The Handler pointer is NULL. • The Handler address is not the same as the one that is installed
AE_NOT_EXIST	There is no handler installed for notifications on this object.

EXCEPTIONS

AE_OK	The handler was successfully installed.
AE_BAD_PARAMETER	At least one of the following is true: <ul style="list-style-type: none"> • The Device handle does not refer to an object of type Device, Processor, ThermalZone, or the root object. • The SpaceId is invalid. • The Handler pointer is NULL.
AE_EXIST	A handler for this address space or operation region is already installed.
AE_NOT_EXIST	ACPI_DEFAULT_HANDLER was specified for an address space that has no default handler.
AE_NO_MEMORY	There was insufficient memory to install the handler.

Functional Description:

This function installs a handler for an Address Space.

6.9.3.1 Interface to Address Space Setup Handlers

Definition of the setup (Address Space start/stop) handler interface for Operation Region Events.

```
typedef
void (*ACPI_ADR_SPACE_SETUP) (
    ACPI_HANDLE      RegionHandle,
    UINT32           Function
    void             *HandlerContext)
    void             **ReturnContext)
```

PARAMETERS

RegionHandle	Handle to the region that is initializing or terminating
Function	The type of function to be performed; must be one of the following manifest constants: <ul style="list-style-type: none"> ACPI_REGION_ACTIVATE (init) ACPI_REGION_DEACTIVATE (terminate)
HandlerContext	An address space specific Context value. Typically this is the context that was passed as a parameter to the AcpiInstallAddressSpaceHandler function.
ReturnContext	An address space specific Context value. This context subsumes the HandlerContext, and this is the context value that is passed to the actual address space handler routine.

RETURN VALUE

None

Functional Description:

This handler is installed via *AcpInstallAddressSpaceHandler*. It is invoked to both initialize and terminate the operation region handling code. The setup handler is first invoked with a function value of `ACPI_REGION_ACTIVATE` upon the first access to the region from AML code. It is called again with a function value of `ACPI_REGION_DEACTIVATE` just before the address space handler is removed.

This function **does not** execute in the context of an interrupt handler.

6.9.3.2 Interface to Address Space Handlers

Definition of the handler interface for Operation Region Events.

```
typedef
void (*ACPI_ADR_SPACE_HANDLER) (
    UINT32          Function,
    UINT32          Address,
    UINT32          BitWidth,
    ACPI_INTEGER    *Value,
    void            *Context)
```

PARAMETERS

Function	The type of function to be performed; must be one of the following manifest constants: <div style="text-align: center;"> <code>ADDRESS_SPACE_READ</code> <code>ADDRESS_SPACE_WRITE</code> </div>
Address	A space-specific address where the operation is to be performed.
BitWidth	The width of the operation, typically 8, 16, 32, or 64.
*Value	A pointer to the value to be written (WRITE), or where the value that was read should be returned (READ).
Context	An address space specific Context value. Typically this is the context that was passed as a parameter to the <i>AcpInstallAddressSpaceHandler</i> function.

RETURN VALUE

None

Functional Description:

This function removes a handler for an Address Space or Operation Region that was previously installed via a call to *AcpInstallAddressSpaceHandler*.

7 OS Services Layer - External Interface Definition

This section contains the definitions of the interfaces that must be exported by the OS Services Layer. The ACPI Core Subsystem requires that all of these interfaces be present. All interfaces to the OS Services Layer *that are intended for use by the ACPI Core Subsystem* are prefixed by the letters “AcpiOs”.

7.1 Environmental

7.1.1 AcpiOsInitialize

Initialize the OSL subsystem.

```
void *  
AcpiOsInitialize (  
    void)
```

PARAMETERS

None

RETURN VALUE

None

Functional Description:

This function allows the OSL to initialize itself. It is called during initialization of the ACPI subsystem.

7.1.2 AcpiOsTerminate

Terminate the OSL subsystem.

```
void *  
AcpiOsTerminate (  
    void)
```

PARAMETERS

None

RETURN VALUE

None

Functional Description:

This function allows the OSL to cleanup and terminate. It is called during termination of the ACPI subsystem.

7.1.3 AcpiOsGetRootPointer

Obtain the Root ACPI table pointer (RSDP).

ACPI_STATUS**AcpiOsGetRootPointer (****UINT32****ACPI_POINTER****Flags,******Address)****PARAMETERS**

Flags

Current addressing mode of the processor – whether paging is currently enabled or not – one of these manifest constants:

ACPI_PHYSICAL_ADDRESSING

ACPI_LOGICAL_ADDRESSING

Address

Where the pointer to the RSDP table is returned.

RETURN VALUE

Status

Exception code that indicates success or reason for failure.

Functional Description:

This function returns the physical address of the ACPI RSDP (Root System Description Pointer) table. The mechanism used to obtain this pointer is platform and/or OS dependent. There are two primary methods used to obtain this pointer and thus implement this interface:

1) On IA-32 platforms, the RSDP is obtained by searching the first megabyte of physical memory for the RSDP signature (“RSD PTR “). On these platforms, this interface should be implemented via a call to the *AcpiFindRootPointer* interface.

2) On IA-64 platforms, the RSDP is obtained from the EFI (Extended Firmware Interface). The pointer in the EFI information block that is passed to the OS at OS startup.

7.1.4 AcpiOsPredefinedOverride

Allow the host OS to override a predefined ACPI object.

ACPI_STATUS
AcpiOsPredefinedOverride (
 ACPI_PREDEFINED_NAMES *PredefinedObject,
 ACPI_STRING **NewValue)

PARAMETERS

PredefinedObject	A pointer to a predefined object (name and initial value.)
NewValue	Where a new value for the predefined object is returned. NULL if there is no override for this object.

RETURN VALUE

Status	Exception code that indicates success or reason for failure.
--------	--

Functional Description:

This function allows the host to override the predefined objects in the ACPI namespace.

7.1.5 AcpiOsTableOverride

Allow the host OS to override a firmware ACPI table.

ACPI_STATUS
AcpiOsTableOverride (
 ACPI_TABLE_HEADER *ExistingTable,
 ACPI_TABLE_HEADER **NewTable)

PARAMETERS

ExistingTable	A pointer to the existing ACPI table header.
NewTable	Where the pointer to the replacement table is returned. The OSL returns NULL if no replacement is provided.

RETURN VALUE

Status	Exception code that indicates success or reason for failure.
--------	--

Functional Description:

This function allows the host to override the ACPI table that was found in the firmware. The OS can examine the header for table signature and version number and decide to replace it if desired.

7.2 Memory Management

These interfaces provide an OS-independent memory management interface.

7.2.1 AcpiOsMapMemory

Map physical memory into the caller's address space.

ACPI_STATUS

```
AcpiOsMapMemory (
    ACPI_PHYSICAL_ADDRESS PhysicalAddress,
    ACPI_SIZE             Length,
    void                  **LogicalAddress)
```

PARAMETERS

PhysicalAddress	A full physical address of the memory to be mapped into the caller's address space.
Length	The amount of memory to be mapped starting at the given physical address.
LogicalAddress	Where the pointer to the mapped memory is returned. Only valid if the return status is AE_OK

RETURN VALUE

Status	Exception code that indicates success or reason for failure.
--------	--

EXCEPTIONS

AE_OK	The physical address was successfully mapped to the returned logical address.
AE_BAD_ADDRESS	The physical address does not refer to valid memory on the system.
AE_NO_MEMORY	There was insufficient memory to allocate the necessary page tables to complete the operation.

Functional Description:

This function maps a physical address into the caller's address space. A logical pointer is returned.

7.2.2 AcpiOsUnmapMemory

Remove a physical to logical memory mapping.

```
void
AcpiOsUnmapMemory (
    void                *LogicalAddress,
    ACPI_SIZE           Length)
```

PARAMETERS

LogicalAddress	The logical address that was returned from a previous call to <i>AcpiOsMapMemory</i> .
Length	The amount of memory that was mapped. This value must be identical to the value used in the call to <i>AcpiOsMapMemory</i> .

RETURN VALUE

None

Functional Description:

This function deletes a mapping that was created by *AcpiOsMapMemory*.

7.2.3 AcpiOsGetPhysicalAddress

Translate a logical address to a physical address.

```
ACPI_STATUS
AcpiOsGetPhysicalAddress (
    void                *LogicalAddress,
    ACPI_PHYSICAL_ADDRESS *PhysicalAddress)
```

PARAMETERS

LogicalAddress	The logical address to be translated.
PhysicalAddress	The physical memory address of the logical address.

RETURN VALUE

AE_OK	The logical address translation was successfully.
AE_ERROR	An error occurred in the translation system call.
AE_BAD_PARAMETER	One or both of the parameters are NULL, no translation was attempted.

Functional Description:

This function translates a logical address to its physical address location.

7.2.4 AcpiOsAllocate

Allocate memory from the dynamic memory pool.
--

```
void *
AcpiOsAllocate (
    ACPI_SIZE          Size)
```

PARAMETERS

Size	Amount of memory to allocate.
------	-------------------------------

RETURN VALUE

Memory	A pointer to the allocated memory. A NULL pointer is returned on error.
--------	---

Functional Description:

This function dynamically allocates memory. The returned memory is not assumed to be initialized to any particular value or values.

7.2.5 AcpiOsFree

Free previously allocated memory.
--

```
void
AcpiOsFree (
    void          *Memory)
```

PARAMETERS

Memory	A pointer to the memory to be freed.
--------	--------------------------------------

RETURN VALUE

None	
------	--

Functional Description:

This function frees memory that was previously allocated via *AcpiOsAllocate*.

7.2.6 AcpiOsReadable

Check if a memory region is readable.

BOOLEAN
AcpiOsReadable (
 void ***Memory**
 UINT32 **Length)**

PARAMETERS

Memory	A pointer to the memory region to be checked.
Length	The length of the memory region, in bytes.

RETURN VALUE

TRUE	If the entire memory region is readable without faults
FALSE	If one or more bytes within the region are unreadable

Functional Description:

This function validates that a pointer to a memory region is valid and the entire region is readable. Used to validate input parameters to the ACPI subsystem.

7.2.7 AcpiOsWritable

Check if a memory region is writable (and readable).

BOOLEAN
AcpiOsWritable (
 void ***Memory,**
 UINT32 **Length)**

PARAMETERS

Memory	A pointer to the memory region to be checked.
Length	The length of the memory region, in bytes.

RETURN VALUE

TRUE	If the entire memory region is both readable and writable without faults
FALSE	If one or more bytes within the region are unreadable or unwritable.

Functional Description:

This function validates that a pointer to a memory region is valid and the entire region is both writable and readable. Used to validate input parameters to the ACPI subsystem..

7.3 Multithreading and Scheduling Services

7.3.1 AcpiOsGetThreadId

Obtain the ID of the currently executing thread.

UINT32
AcpiOsGetThreadId (
void)

PARAMETERS

None

RETURN VALUE

ThreadId A unique value that represents the ID of the currently executing thread. For single threaded implementations, a constant integer is acceptable. The value 0xFFFFFFFF (-1) is reserved and must not be returned by this interface.

Functional Description:

This function returns the ID of the currently executing thread. The value must be non-zero and must be unique to the executing thread.

7.3.2 AcpiOsQueueForExecution

Schedule a procedure for deferred execution.

ACPI_STATUS
AcpiOsQueueForExecution (
 UINT32 Priority,
 OSL_EXECUTION_CALLBACK Function,
 void *Context)

PARAMETERS

Priority Requested priority of the execution – one of these manifest constants:

OSL_PRIORITY_HIGH

OSL_PRIORITY_MED

OSL_PRIORITY_LO

Function	Address of the procedure to execute.
Context	A context value to be passed to the called procedure.

RETURN VALUE

Status	Exception code that indicates success or reason for failure.
--------	--

EXCEPTIONS

AE_OK	The procedure was successfully queued for execution by the host operating system. This does not indicate that the procedure has actually executed, however.
AE_BAD_PARAMETER	At least one of the following is true: <ul style="list-style-type: none"> • The <i>Priority</i> is invalid. • The <i>Function</i> pointer is NULL.

Functional Description:

This function queues a procedure for later scheduling and execution.

7.3.3 AcpiOsSleep

Suspend the running task (course granularity).

ACPI_STATUS
AcpiOsSleep (
 UINT32
 UINT32

Seconds,
Milliseconds)

PARAMETERS

Seconds	The number of whole seconds to sleep.
Milliseconds	The number of partial seconds to sleep, in milliseconds.

RETURN VALUE

Status	Exception code that indicates success or reason for failure.
--------	--

EXCEPTIONS

AE_OK	The running thread slept for the time specified.
AE_BAD_PARAMETER	TBD!!!!
AE_ERROR	The running thread did not sleep because of a host OS error.

Functional Description:

This function sleeps for the specified time. Execution of the running thread is suspended for this time. The sleep granularity is one millisecond.

7.3.4 AcpiOsStall

Suspend the running task (fine granularity).

ACPI_STATUS
AcpiOsSleepUsec (
UINT32

Microseconds)

PARAMETERS

Microseconds	The amount of time to delay in microseconds.
--------------	--

RETURN VALUE

Status	Exception code that indicates success or reason for failure.
--------	--

EXCEPTIONS

AE_OK	The running thread slept for the time specified.
AE_ERROR	The running thread did not sleep because of a host OS error.

Functional Description:

This function sleeps for the specified time. Execution of the running thread is suspended for this time. The sleep granularity is one microsecond.

7.4 Mutual Exclusion and Synchronization

Thread synchronization and locking.

These interfaces **MUST** perform parameter validation of the input handle to at least the extent of detecting a null handle and returning the appropriate exception.

7.4.1 AcpiOsCreateSemaphore

Create a semaphore.

```

ACPI_STATUS
AcpiOsCreateSemaphore (
    UINT32          MaxUnits,
    UINT32          InitialUnits,
    ACPI_HANDLE    *OutHandle)
    
```

PARAMETERS

MaxUnits	The maximum number of units this semaphore will be required to accept.
InitialUnits	The initial number of units to be assigned to the semaphore.
OutHandle	A pointer to a location where a handle to the semaphore is to be returned.

RETURN VALUE

Status	Exception code that indicates success or reason for failure.
--------	--

EXCEPTIONS

AE_OK	The semaphore was successfully created.
AE_BAD_PARAMETER	At least one of the following is true: <ul style="list-style-type: none"> • The <i>InitialUnits</i> is invalid. • The <i>OutHandle</i> pointer is NULL.
AE_NO_MEMORY	Insufficient memory to create the semaphore.

Functional Description:

Create a standard semaphore. The *MaxUnits* parameter allows the semaphore to be tailored to specific uses. For example, a *MaxUnits* value of one indicates that the semaphore is to be used as a *mutex*. The underlying OS object used to implement this semaphore may be different than if *MaxUnits* is greater than one (thus indicating that the semaphore will be used as a general purpose semaphore.) The ACPI Core Subsystem creates semaphores of both the mutex and general-purpose variety.

RETURN VALUE

Status Exception code that indicates success or reason for failure.

EXCEPTIONS

AE_OK The requested units were successfully received.
 AE_BAD_PARAMETER The *Handle* is invalid.
 AE_TIME The units could not be acquired within the specified time limit.

Functional Description:

Wait for the specified number of units from a semaphore.

Implementation notes:

1. The implementation of this interface must support timeout values of zero. This is frequently used to determine if a call to the interface with an actual timeout value would block. In this case, *AcpiOsWaitSemaphore* must return either an *E_OK* if the units were obtained immediately, or an *AE_TIME* to indicate that the requested units are not available. Single threaded OSL implementations should always return *AE_OK* for this interface.
2. The implementation must also support arbitrary timed waits in order for ASL functions such as *Wait ()* to work properly.

7.4.4 AcpiOsSignalSemaphore

Send units to a semaphore.

ACPI_STATUS

AcpiOsSignalSemaphore (
ACPI_HANDLE Handle,
UINT32 Units)

PARAMETERS

Handle A handle to a semaphore object that was returned by a previous call to *AcpiOsCreateSemaphore*.
 Units The number of units to send to the semaphore.

RETURN VALUE

Status Exception code that indicates success or reason for failure.

EXCEPTIONS

AE_OK The semaphore was successfully signaled.
 AE_BAD_PARAMETER The *Handle* is invalid.

AE_LIMIT The semaphore has already been signaled MaxUnits times. No more units can be accepted.

Functional Description:

Send the requested number of units to a semaphore. Single threaded OSL implementations should always return AE_OK for this interface.

7.4.5 AcpiOsCreateLock

Create a spin lock.

ACPI_STATUS
AcpiOsCreateLock (
 ACPI_HANDLE ***OutHandle)**

PARAMETERS

OutHandle A pointer to a location where a handle to the lock is to be returned.

RETURN VALUE

Status Exception code that indicates success or reason for failure.

EXCEPTIONS

AE_OK The semaphore was successfully created.

AE_BAD_PARAMETER The *OutHandle* pointer is NULL.

AE_NO_MEMORY Insufficient memory to create the semaphore.

Functional Description:

Create a spin lock. Spin locks are used in the ACPI CA subsystem only when there is requirement for mutual exclusion on data structures that are accessed by both interrupt handlers and normal code.

7.4.6 AcpiOsDeleteLock

Delete a spin lock.

ACPI_STATUS
AcpiOsDeleteLock (
 ACPI_HANDLE **Handle)**

PARAMETERS

Handle A handle to a lock object that was returned by a previous call to *AcpiOsCreateLock*.

7.4.8 AcpiOsReleaseLock

Release a spin lock.

ACPI_STATUS
AcpiOsReleaseLock (
ACPI_HANDLE
UINT32

Handle,
Flags)

PARAMETERS

Handle	A handle to a lock object that was returned by a previous call to <i>AcpiOsCreateLock</i> .
Flags	One of the following manifest constants:
	ACPI_ISR This call is being made from an interrupt handler.
	ACPI_NON_ISR This call is not being made from an interrupt handler.

RETURN VALUE

Status	Exception code that indicates success or reason for failure.
--------	--

EXCEPTIONS

AE_OK	The lock was successfully released.
AE_BAD_PARAMETER	The <i>Handle</i> is invalid.

Functional Description:

Release a previously acquired spin lock. Single threaded OSL implementations should always return AE_OK for this interface.

7.5 Interrupt Handling

Interrupt handler installation and removal.

7.5.1 AcpiOsInstallInterruptHandler

Install a handler for a hardware interrupt level.

ACPI_STATUS
AcpiOsInstallInterruptHandler (
 UINT32 **InterruptLevel,**
 OSL_HANDLER **Handler,**
 void ***Context)**

PARAMETERS

InterruptLevel	Interrupt level that the handler will service.
Handler	Address of the handler.
Context	A context value that is passed to the handler when the interrupt is dispatched.

RETURN VALUE

Status	Exception code that indicates success or reason for failure.
--------	--

EXCEPTIONS

AE_OK	The handler was successfully installed.
AE_BAD_PARAMETER	At least one of the following is true: <ul style="list-style-type: none"> • The <i>InterruptNumber</i> is invalid. • The <i>Handler</i> pointer is NULL.
AE_EXIST	A handler for this interrupt level is already installed.

Functional Description:

This function installs an interrupt handler for a hardware interrupt level. The ACPI driver must install an interrupt handler to service the SCI (System Control Interrupt) which it owns. The interrupt level for the SCI interrupt is obtained from the ACPI tables.

7.5.1.1 Interface to OS-independent Interrupt Handlers

Definition of the interface for OS-independent interrupt handlers.

```
typedef
UINT32 (*OSL_HANDLER) (
    void                *Context)
```

PARAMETERS

Context The Context value that was passed as a parameter to the AcpiOsInstallInterruptHandler function.

RETURN VALUE

HandlerActionTaken The handler should return one of the following manifest constants:

INTERRUPT_HANDLED

INTERRUPT_NOT_HANDLED

INTERRUPT_ERROR

Functional Description:

The OS-independent interrupt handler must be called from an OSL interrupt handler “wrapper” that exists within the OS Services Layer. It is the responsibility of the OS Services Layer to manage the installed interrupt handler(s), and dispatch interrupts to the handler(s) appropriately.

7.5.2 AcpiOsRemoveInterruptHandler

Remove an interrupt handler.

```
ACPI_STATUS
AcpiOsRemoveInterruptHandler (
    UINT32                InterruptNumber,
    OSL_HANDLER           Handler)
```

PARAMETERS

InterruptNumber Interrupt number that the handler is currently servicing.

Handler Address of the handler that was previously installed.

RETURN VALUE

Status Exception code that indicates success or reason for failure.

EXCEPTIONS

AE_OK The handler was successfully removed.

AE_BAD_PARAMETER	At least one of the following is true: <ul style="list-style-type: none"> • The <i>InterruptNumber</i> is invalid. • The <i>Handler</i> pointer is NULL. • The <i>Handler</i> address is not the same as the one that is installed
AE_NOT_EXIST	There is no handler installed for this interrupt level.

Functional Description:

Remove a previously installed hardware interrupt handler.

7.6 Address Space Access

7.6.1 Memory and Memory Mapped I/O

These interfaces allow the OS Services Layer to implement memory access in any manner that is acceptable to the host OS. The actual hardware I/O instructions may execute within the OS Services Layer itself, or these calls may be translated into additional OS calls — such as calls to a Hardware Abstraction Component.

These calls are used by the ACPI CA for small amounts of data transfer only, such as memory mapped I/O. For large transfers (such as reading the ACPI tables), the ACPI CA code will call *AcpiOsMapMemory* instead.

7.6.1.1 AcpiOsReadMemory

Read a value from a memory location.

ACPI_STATUS

AcpiOsReadMemory (
 ACPI_PHYSICAL_ADDRESS **Address,**
 UINT32 ***Value,**
 UINT32 **Width)**

PARAMETERS

Address	Memory address to be read.
Value	A pointer to a location where the data is to be returned.
Width	The memory width in bits, either 8, 16, or 32.

RETURN VALUE

Status	Exception code that indicates success or reason for failure.
--------	--

Functional Description:

This function is used to read a data from the specified memory location. The data is zero extended to fill the 32-bit return value even if the bit width of the location is less than 32. In other words, a full 32 bits are written to the return *Value* regardless of the number of bits that were read from the memory at *Address*. The caller must ensure that no data will be overwritten by this call.

7.6.1.2 AcpiOsWriteMemory

Write a value to a memory location.

ACPI_STATUS

AcpiOsWriteMemory (
ACPI_PHYSICAL_ADDRESS **Address,**
UINT32 **Value,**
UINT32 **Width)**

PARAMETERS

Address	Memory address where data is to be written.
Value	Data to be written to the memory location.
Width	The memory width in bits, either 8, 16, or 32.

RETURN VALUE

Status	Exception code that indicates success or reason for failure.
--------	--

Functional Description:

This function writes data to the specified memory location. If the bit width of the memory location is less than 32, only the lower significant bits of the *Value* parameter are written.

7.6.2 Port Input/Output

These interfaces allow the OS Services Layer to implement hardware I/O services in any manner that is acceptable to the host OS. The actual hardware I/O instructions may execute within the OS Services Layer itself, or these calls may be translated into additional OS calls — such as calls to a Hardware Abstraction Component.

7.6.2.1 AcpiOsReadPort

Read a value from an input port.

ACPI_STATUS

AcpiOsReadPort (
ACPI_IO_ADDRESS **Address,**
UINT32 ***Value,**
UINT32 **Width)**

PARAMETERS

Address	Hardware I/O port address to read from.
Value	A pointer to a location where the data is to be returned.
Width	The port width in bits, either 8, 16, or 32.

RETURN VALUE

Status	Exception code that indicates success or reason for failure.
--------	--

Functional Description:

This function reads data from the specified input port. The data is zero extended to fill the 32-bit return value even if the bit width of the port is less than 32.

7.6.2.2 AcpiOsWritePort

Write a value to an output port.

ACPI_STATUS
AcpiOsWritePort (
 ACPI_IO_ADDRESS **Address,**
 UINT32 **Value,**
 UINT32 **Width)**

PARAMETERS

Address	Hardware I/O port address to read from.
Value	The value to be written.
Width	The port width in bits, either 8, 16, or 32.

RETURN VALUE

Status	Exception code that indicates success or reason for failure.
--------	--

Functional Description:

This function writes data to the specified input port. If the bit width of the port is less than 32, only the lower significant bits of the *Value* parameter are written.

7.6.3 PCI Configuration Space

These interfaces allow the OS Services Layer to implement PCI Configuration Space services in any manner that is acceptable to the host OS. The actual hardware I/O instructions may execute within the OS Services Layer itself, or these calls may be translated into additional OS calls — such as calls to a Hardware Abstraction Component.

7.6.3.1 AcpiOsReadPciConfiguration

Read a value from a PCI configuration register.

ACPI_STATUS
AcpiOsReadPciConfiguration (
ACPI_PCI_ID **PciId,**
UINT32 **Register,**
ACPI_INTEGER ***Value,**
UINT32 **Width)**

PARAMETERS

PciId	The full PCI configuration space address, consisting of a segment number, bus number, device number, and function number.
Register	The PCI register address to be read from.
Value	A pointer to a location where the data is to be returned.
Width	The register width in bits, either 8, 16, 32, or 64.

RETURN VALUE

Status	Exception code that indicates success or reason for failure.
--------	--

Functional Description:

This function reads data from the specified PCI configuration port. The data is zero extended to fill the 64-bit return value even if the bit width of the location is less than 64.

7.6.3.2 AcpiOsWritePciConfiguration

Write a value to a PCI configuration register.

ACPI_STATUS
AcpiOsWritePciConfiguration (
ACPI_PCI_ID **PciId,**
UINT32 **Register,**
ACPI_INTEGER **Value,**
UINT32 **Width)**

PARAMETERS

PciId	The full PCI configuration space address, consisting of a segment number, bus number, device number, and function number.
Register	The PCI register address to be written to.
Value	Data to be written.

Width The register width in bits, either 8, 16, 32, or 64.

RETURN VALUE

Status Exception code that indicates success or reason for failure.

Functional Description:

This function writes data to the specified PCI configuration port. If the bit width of the register is less than 64, only the lower significant bits of the Value are written.

7.6.3.3 AcpiOsDerivePciId

Derive and update a PCI ID for a PCI device object and PCI operation region.

ACPI_STATUS

AcpiOsDerivePciId (
 ACPI_HANDLE **DeviceHandle,**
 ACPI_HANDLE **PciRegionHandle,**
 ACPI_PCI_ID ****PciId)**

PARAMETERS

DeviceHandle	A handle to the PCI device.
PciRegionHandle	A handle to the PCI configuration space Operation Region.
PciId	Input: The full PCI ID (The full PCI configuration space address, consisting of a segment number, bus number, device number, and function number) as obtained from control methods within the BIOS ACPI tables. Output: Where the derived PCI ID is returned. Some or all of the PCI ID subfields may be updated by this function.

RETURN VALUE

Status Exception code that indicates success or reason for failure.

Functional Description:

This function derives a full PCI ID for a PCI device, consisting of a Segment number, a Bus number, and a Device number.

The PCI hardware dynamically configures PCI bus numbers depending on the bus topology discovered during system initialization. The *AcpiOsDerivePciId* function is invoked by the ACPI CA subsystem during configuration of a *PCI_Config* Operation Region in order to (possibly) update the Bus number in the *PciId* with the actual Bus number as determined by the hardware and operating system configuration.

The *PciId* parameter is initially populated by the ACPI CA subsystem during the Operation Region initialization. ACPI CA then calls *AcpiOsDerivePciId*, which is expected to make any necessary modifications to the Segment, Bus, or Device number PCI ID subfields as appropriate for the current hardware and OS configuration.

7.7 Stream I/O

These interfaces provide formatted stream I/O. Used mainly for debug output, these functions may be redirected to whatever output device or file is appropriate for the host operating system.

7.7.1 AcpiOsPrintf

Formatted stream output.

```

INT32
AcpiOsPrintf (
    OSL_FILE
    const char
    ...
    *Stream,
    *Format,
    <variable argument list>)
  
```

PARAMETERS

Stream	Open stream to write to. NULL is defined to be the debugger output channel.
Format	A standard print format string.
...	Variable parameter list.

RETURN VALUE

Count	Number of parameters successfully printed. -1 on error.
-------	---

Functional Description:

This function provides formatted output to an open OSL stream.

7.7.2 AcpiOsVprintf

Formatted stream output.

```

INT32
AcpiOsVprintf (
    OSL_FILE
    const char
    va_list
    *Stream,
    *Format,
    Args)
  
```

PARAMETERS

Stream	Open stream to write to. NULL is defined to be the debugger output channel.
Format	A standard printf format string.
Args	A variable parameter list.

RETURN VALUE

Count Number of parameters successfully printed. -1 on error.

Functional Description:

This function provides formatted output to an open OSL stream via the va_list argument format.

7.7.3 AcpiOsRedirectOutput

Redirect the debug output.

```
void
AcpiOsRedirectOutput (
    void                                          *Destination)
```

PARAMETERS

Destination An open file handle or pointer. Debug output will be redirected to this handle/pointer. The format of this parameter is OS-specific.

RETURN VALUE

None

Functional Description:

This function redirects the output of AcpiOsPrintf and AcpiOsVprintf to the specified destination. Usually used to redirect output to a file.

7.8 Miscellaneous

7.8.1 AcpiOsSignal

Break to the debugger or display a breakpoint message.

```
ACPI_STATUS
AcpiOsSignal (
    UINT32                                          Function,
    void                                          *Info)
```

PARAMETERS

Function Signal to be sent to the host operating system – one of these manifest constants:

ACPI_SIGNAL_FATAL

ACPI_SIGNAL_BREAKPOINT

RETURN VALUE

Status	Exception code that indicates success or reason for failure.
--------	--

Functional Description:

This function is used to pass various signals and notifications to the host operating system.

7.8.1.1 ACPI_SIGNAL_FATAL

This signal corresponds to the AML **Fatal** opcode. It is sent to the host OS only when this opcode is encountered in the AML stream. The host OS may or may not return control from this signal.

The definition of the Info structure for this signal is as follows:

```
typedef struct AcpiFatalInfo
{
    UINT32                Type;
    UINT32                Code;
    UINT32                Argument;
} ACPI_SIGNAL_FATAL_INFO;
```

7.8.1.2 ACPI_SIGNAL_BREAKPOINT

This signal corresponds to the AML **Breakpoint** opcode. The OSL implements a “Breakpoint” operation as appropriate for the host OS. If in debug mode, this interface may cause a break into the host kernel debugger.

The definition of the Info structure for this signal is as follows:

```
char                *BreakpointMessage;
```

7.8.2 AcpiOsGetLine

Get a input line of data.

```
ACPI_STATUS
AcpiOsGetLine (
    char                *Buffer)
```

PARAMETERS

Message	A message string related to the breakpoint
---------	--

RETURN VALUE

Status	Exception code that indicates success or reason for failure.
--------	--

Functional Description:

The purpose of this function is to support the ACPI Debugger, and it is therefore optional depending on whether ACPI debugger support is desired.

8 ACPI Debugger

8.1 Overview

The ACPI/AML Debugger is an optional subcomponent of the ACPI CA Core Subsystem. It can be operated standalone or in conjunction with (or as an extension of) a native kernel debugger. The debugger provides the ability to load ACPI tables, dump internal data structures, execute control methods, disassemble control methods, single step control methods, and set breakpoints within control methods.

8.2 Supported Environments

The debugger can be executed in a ring 0 (kernel) or ring 3 (application) environment. The following combinations of debugger and front-end (user-interface) are supported:

- Ring 0 Debugger, Ring 0 Front-End: In this case, the front-end is a host kernel debugger, and the Debugger operates as an extension to the host debugger.
- Ring 0 Debugger, Ring 3 Front-End: In this mode, the front-end is a ring 3 application that obtains the command lines from the user and sends them to the debugger executing in Ring 0. The actual mechanism used for this communication is dependent on the host operating system.
- Ring 3 Debugger, Ring 3 Front-End: In this mode, the entire ACPI CA subsystem (including the debugger) resides in a Ring 3 application. A single thread can be used for the user interface, debugger, and AML control method execution.

8.2.1 The AcpiExec Utility

An example of the Ring3/Ring3 model of execution is the Windows-based *AcpiExec* utility. This Windows application includes the entire ACPI CA subsystem (including the Debugger) and allows the user to load ACPI tables from files and execute methods contained in the tables.

Of course, hardware and memory access from Ring 3 is very limited.

8.3 Debugger Architecture

The ACPI debugger consists of the following architectural elements:

- A command line interpreter that receives entire command lines from the host, parses them into commands and parameters, and dispatches the request to the appropriate handler for the command.
- A group of modules that implement the various debugger commands.
- A group of callback routines that are invoked by the interpreter/dispatcher during the execution control methods. These callbacks enable the single stepping of control methods and the display of arguments to each executed control method.

When executing in a Ring 0 environment, the debugger initialization creates a separate thread for the debugger CLI. This threads performs the following tasks until the debugger is shut down:

1. Wait for a command line by calling the *AcpiOsGetLine* interface
2. Execute the command

All output from the debugger is via the *AcpiOsPrint* and *AcpiOsVprintf* interfaces.

The overall architecture of the ACPI Debugger is shown in the diagram below. Note how the Debugger CLI uses the *AcpiOsGetLine* interface to obtain user command lines, and how output from the entire debugger and ACPI subsystem can be directed to the console, a file, or both via the implementation of the *AcpiOsPrint* interface within the OSL layer. Also note how the debugger and ACPI subsystem can reside in a different protection ring than the user console support and file I/O support.

Figure 9. ACPI Debugger Architecture

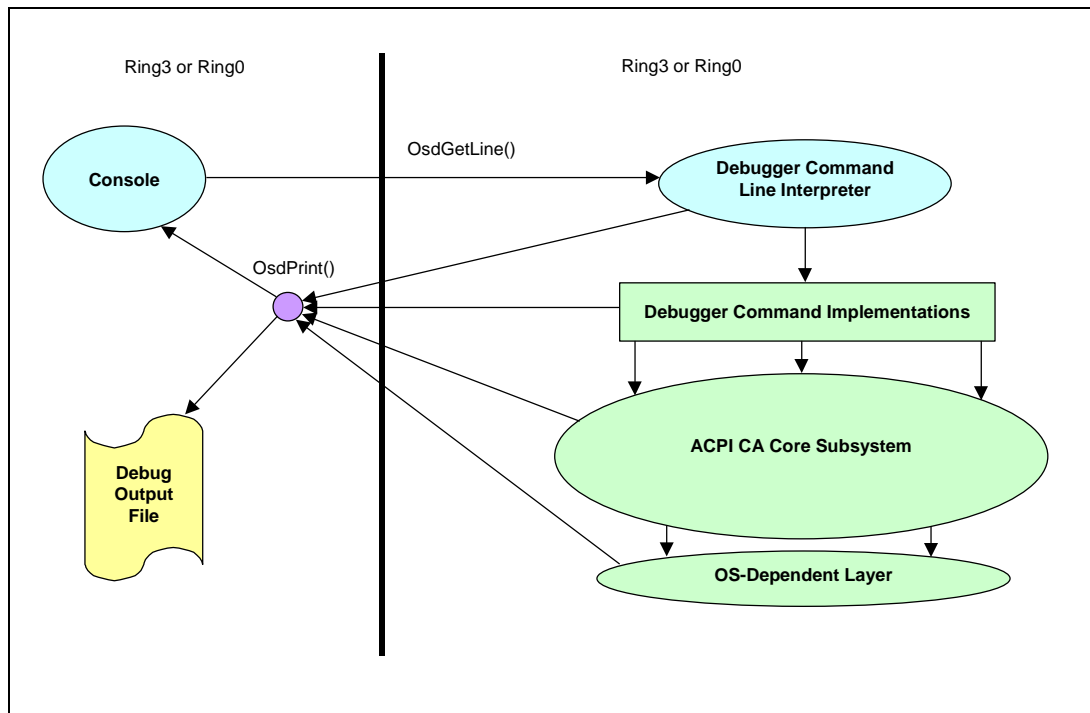

8.4 Configuration and Installation

The basic idea behind the debugger thread is that it receives a command line from *somewhere* and then asynchronously executes it. The command line can come from a ring 3 application (a debugger front-end), or it can come from the resident kernel debugger (you would install a debugger extension that forwards command lines to the debugger.)

With this in mind, there are several key components of the debugger:

1. **DbInitialize** – Initializes the debugger semaphores and creates the debugger thread, DbExecuteThread
2. **DbCommandDispatch** – This is the actual command execution code

3. **DbExecuteThread** – Waits for a command to become available (as indicated by the `MTX_DEBUG_CMD_READY` mutex), executes the command, (via `DbCommandDispatch`), then signals command completion via the `MTX_DEBUG_CMD_COMPLETE` mutex.
4. **DbUserCommands** – An example command loop that must execute in its own thread (this is the *caller* thread, not a thread that is part of the debugger). This loop obtains a command line via `AcpiOsGetLine`, puts it into the `LineBuf` buffer, and signals the `DbExecuteThread` that a command line is available. It is not necessary to use this procedure, however, if command lines become available from somewhere besides `AcpiOsGetLine`.
5. **DbSingleStep** – Called from the dispatcher just before an AML opcode is executed. Implements its own command loop that obtains command lines from either the `MTX_DEBUG_CMD_READY` mutex (multi-thread mode), or by calling `AcpiOsGetLine` directly (single thread mode). Drops out of the loop when the control method is aborted or is allowed to continue running (perhaps just to the next opcode...)

This is the basic thread model and handshake with the outside world. To integrate the debugger into a specific environment, it is your responsibility to get command lines to the `DbExecuteThread` via the `LineBuf` and the `MTX_DEBUG_CMD_READY` mutex. Alternatively, you can just call the `DbCommandDispatch` directly if you don't need an asynchronous debugger thread. Additional explanation follows.

The `AcpiExec Ring3` application uses `DbUserCommands` to process command lines (`DbUserCommands` is actually called from `aemain.c`). However, if integrating with a kernel debugger, you will probably want to implement your own mechanism instead of using the `DbUserCommands` loop. I would imagine this would entail the following:

1. Install a small extension to the kernel debugger that receives command lines intended for that extension.
2. Copy the command line to the `LineBuf`.
3. Signal the `DbExecuteThread` that a command is available. (`MTX_DEBUG_CMD_READY`).
4. Wait for the command to complete (`MTX_DEBUG_CMD_COMPLETE`).
5. Return to the kernel debugger.

If you don't need the extra debugger thread, you can simply execute commands in the caller's context:

1. Install a small extension to the kernel debugger that receives command lines intended for that extension.
2. Copy the command line to the `LineBuf`.
3. Call `DbCommandDispatch` to execute the command directly.
4. Return to the kernel debugger.

The behavior of the debugger can be configured as follows (via the `config.h` header):

```
#define DEBUGGER_THREADING    DEBUGGER_SINGLE_THREADED
```

This sets the single thread mode of the debugger.

```
#define DEBUGGER_THREADING    DEBUGGER_MULTI_THREADED
```

This sets the multi-thread mode of the debugger.

Basically, in multithread mode, we just wait for some other thread to fill the LineBuf with a command and signal the semaphore. In single thread mode, we explicitly call AcpiOsGetLine to get a command line.

8.5 Debugger Commands

There are three classes of commands supported by the debugger:

1. The **General-Purpose** commands are available in all modes of the debugger. These commands provide the basic functionality of loading tables, dumping internal data structures, and starting the execution of control methods.
2. The **Control Method Execution** Commands are available only during the single-step execution of control methods. These commands allow the display and modification of method arguments and local variables, control method disassemble, and the setting of method breakpoints
3. The **File I/O** Commands are available only if a filesystem is available to the debugger.

8.5.1 General Purpose Commands

8.5.1.1 Allocations

Memory allocation status

SYNTAX

- Allocations

This command dumps the current status of the dynamic memory allocations, as maintained by the ACPI subsystem debug memory allocation tracking mechanism. Primarily used to detect memory leaks, the mechanism tracks the allocation and freeing of each memory block, and maintains statistics on the amount of memory allocated, the number of allocations, etc.

8.5.1.2 Dump

Display objects and memory

SYNTAX

- Dump <Address>|<Namepath> [Byte|Word|Dword|Qword]

A generic command to dump all internal ACPI objects and memory. The operand can be a namespace name, a pointer to an ACPI object, or a pointer to random memory in the current address space. The command determines the type of ACPI object and decodes it into the appropriate fields

8.5.1.3 Exit

Terminate

SYNTAX

- Exit

Terminate the ACPI subsystem and exit the debugger.

8.5.1.4 Help

Get help

SYNTAX

- Help

Displays a help screen with the syntax of each command and a short description of each.

8.5.1.5 History (! And !!)

Command line recall

SYNTAX

History

! <Command Number>

!!

last few commands. The “!” command can be used to select and re-execute a particular command from the numbered command buffer, or the “!!” command can be used to simply re-execute the immediately previous command.

8.5.1.6 Level

Set debug level

SYNTAX

- Allocations

Sets the global debug output level of the ACPI subsystem for both output directed to a file and output to the console.

8.5.1.7 Quit

Terminate

SYNTAX

- Quit

Terminate the current execution mode. If executing (single stepping) a control method, the method is immediately aborted with an exception and the debugger returns to the normal command line mode. If no control method is executing, the ACPI subsystem is terminated and the debugger exits.

8.5.1.8 Stats

Namespace statistics

SYNTAX

- Stats

Display namespace statistics that were gathered when the namespace was loaded. This includes information about the number of objects and their types, the amount of dynamic memory required, and the number of search operations performed on the namespace database.

8.5.1.9 Unload

Unload table

SYNTAX

- Unload <Table ID>

Unload an ACPI Table <Not implemented>

8.5.2 Namespace Access Commands

8.5.2.1 Event

Generate an ACPI Event

SYNTAX

- Event <Value>

Generate an ACPI event to test event handling <NOT IMPLEMENTED>

8.5.2.2 Find

Find names in the Namespace

SYNTAX

- Find <name>

Find an ACPI name or names within the current ACPI namespace. All names that match the given name are displayed as they are found in the namespace. Names are up to four characters, and wildcards are supported. A '?' in the name will match any character. Thus, the wildcarded name "A???" will match all names in the namespace that begin with the letter "A".

8.5.2.3 Methods

List all control methods

SYNTAX

- Methods

Displays a list of all control methods (and their full pathnames) that are contained within the current ACPI namespace. (Alias for the command "Object Methods".)

8.5.2.4 Namespace

List the namespace

SYNTAX

- Namespace [<Address> | <Namepath>] [Depth]

Dump all or a portion of the current ACPI namespace. If given with no parameter, this command displays the entire namespace, one named object per line with information about each object. If given the name of an object or a pointer to an object, it displays the subtree rooted by that object.

8.5.2.5 Notify

Generate a Notify

SYNTAX

- Notify <Namepath> <Value>

Generates a notify on the specified device. This means that the notify handler for the device is invoked with the parameters specified.

8.5.2.6 Object

Display typed objects**SYNTAX**

- Object <Object Type>

Display objects within the namespace of the requested type.

8.5.2.7 Owner

Display namespace by owner ID**SYNTAX**

- Owner <Owner ID> [Depth]

Display objects within the namespace owned by the requested Owner ID.

8.5.2.8 Prefix

Get or Set current prefix**SYNTAX**

- Prefix [<NamePath>]

Sets the pathname prefix that is prepended to namestrings entered into the debug and execute commands. This command is the equivalent of the “CD” command.

8.5.2.9 References

Find all references to an object within the namespace**SYNTAX**

- References <Address>

Display all references to the object at the specified address.

8.5.2.10 Resources

Display device resources**SYNTAX**

- Resources <Address>

Display resource lists (_PRS, _CRS, etc.) for the Device object at the specified address.

8.5.2.11 Terminate

Shutdown ACPI subsystem

SYNTAX

- Terminate

Shutdown the ACPI subsystem, but don't exit the debugger. This command is useful to find memory leaks in the form of objects left over after the subsystem deletes the entire namespace and all known internal objects. Any objects left over after shutdown are displayed and may be examined.

8.5.2.12 Thread

Execute a control method with multiple threads

SYNTAX

- Thread <number of threads> <number of loops> <Pathname>

Create the specified number of threads to execute the control method at <Pathname>. Each thread will execute the method <number of loops> times. The command waits until all threads have completed before returning.

8.5.3 Control Method Execution Commands

During single stepping of a control method, the following commands are available. The debugger enters a slightly different command mode (as indicated by the '%' prompt) when single stepping a control method to indicate that these commands are now available

8.5.3.1 Arguments

Display Method arguments

SYNTAX

Arguments

Args

Display all arguments to the currently executing control method

8.5.3.2 Breakpoint

Set control method breakpoint

SYNTAX

- Breakpoint <AML Offset>

Set a breakpoint at the AML offset given. When execution reaches this offset, execution is stopped and the debugger is entered.

8.5.3.3 Call

Run to next call

SYNTAX

- Call

Step execution of the current control method until the next method invocation (call) is encountered.

8.5.3.4 Debug

Single step a control method

SYNTAX

- Debug <Namepath> [Arg0, Arg1,...]

Begin execution of a control method in single step mode. Each AML opcode and its associated operand(s) is disassembled and displayed before execution. A single carriage return (Enter) single steps to the next AML opcode. The values of the arguments and the value of the return value (if any) are displayed for each opcode.

8.5.3.5 Execute

Execute a control method

SYNTAX

- Execute <Namepath> [Arg0, Arg1,...]

Execute a control method. This command begins execution of the named method and lets it run to completion without single stepping. The return result if any is displayed after execution completes.

8.5.3.6 Go

Run method to next breakpoint

SYNTAX

- Go

Cease single step mode and let the control method run freely until either a breakpoint is reached or the method terminates.

8.5.3.7 Gpe

Generate a GPE

SYNTAX

- Gpe <Block Address> <GPE number>

Generate a GPE at the GPE number within the GPE block specified at the Block Address. Use 0 for the block address to generate a GPE within the permanent FADT-defined GPE blocks (GPE0 and GPE1.).

8.5.3.8 Gpes

Display GPE block information

SYNTAX

- Gpes

Display information on all GPE blocks, including the FADT-defined GPE blocks (GPE0 and GPE1) and all loaded GPE Block Devices.

8.5.3.9 Information

Info about a control method

SYNTAX

- Information

8.5.3.10 Into

Step into call

SYNTAX

- Into

Step into a control method invocation instead of over the call. The default single step behavior is to step **over** control method calls, meaning that the call is executed and single stepping resumes after the call returns. Use this command to single step the execution of a called control method.

8.5.3.11 List

Disassemble AML code

SYNTAX

- List [<Opcode count>]

Disassemble the AML code of the current control method from the current AML offset for the length given. Useful for finding interesting places to set breakpoints.

8.5.3.12 Locals

Display method local variables

SYNTAX

- Locals

Display the current values of all of the local variables for the current control method. When stepping into a control method invocation, the locals of the newly invoked method are displayed during the time that method is single stepped.

8.5.3.13 Results

Display method result stack

SYNTAX

- Results

Display the current contents of the “Result Stack” for the control method.

8.5.3.14 Set

Set arguments or locals

SYNTAX

- Set Arg|Local <ID> <Value>

Set the value of any of a method's arguments or local variables

8.5.3.15 Stop

Stop method

SYNTAX

- Stop

Terminate the currently executing control method

8.5.3.16 Tree

Display calling tree

SYNTAX

- Tree

Display the calling tree of the current method.

8.5.4 File I/O Commands

8.5.4.1 Close

Close debug output file

SYNTAX

- Close

Close the debug output file, if one is currently open. Using Exit or Quit to terminate the debugger will automatically close any open file.

8.5.4.2 Load

Load ACPI table

SYNTAX

- Load <Filename>

Load an ACPI table into the namespace from a file.

8.5.4.3 Open

Open debug output file

SYNTAX

- Open <Filename>

Open a file for debug output.

9 Tools and Utilities

9.1 AcpiDump

This utility is a DOS-based table disassembler and table extractor. The 16-bit version can be put on a DOS boot diskette and used to extract the ACPI tables from memory and store them to a disk file.

9.2 AcpiExec

This Windows-based utility can be used to load any ACPI tables from file(s), execute control methods, single step control methods, inspect the ACPI namespace, etc. When generated from source, it contains the entire ACPI core subsystem including the ACPI Debugger.

9.3 WDM Driver and Test Application

The WDM driver contains the ACPI Core Subsystem and the Debugger. The Ring3 test application can be used to communicate with the ACPI Debugger. Control methods can be executed or single stepped, the namespace can be dumped and inspected, etc. All commands of the ACPI Debugger are available, as well as commands unique to the test application for the execution of the various Acpi* interfaces to the core subsystem.

10 Subsystem User Guide

10.1 Using the ACPI Core Subsystem Interfaces

10.1.1 Initialization Sequence

In order to allow the most flexibility for the host operating system, there is no single interface that initializes the entire ACPI subsystem. Instead, the subsystem is initialized in stages, at the times that are appropriate for the host OS. The following example shows the sequence of initialization calls that must be made; it is up to the host interface (OS Services Layer) to make these calls when they are appropriate.

1. Initialize all ACPI Code:

```
Status = AcpiInitializeSubsystem ();
```

2. Load the ACPI tables from the firmware and build the internal namespace:

```
Status = AcpiLoadTables ();
```

3. Complete initialization and put the system into ACPI mode:

```
Status = AcpiEnableSubsystem ();
```

10.1.2 Shutdown Sequence

The ACPI Core Subsystem does not absolutely require a shutdown before the system terminates. It does not hold any cached data that must be flushed before shutdown. However, if the ACPI subsystem is to be unloaded at any time during system operation, the subsystem should be shutdown so that resources that are held internally can be released back to the host OS. These resources include memory segments, an interrupt handler, and the ACPI hardware itself. To shutdown the ACPI Core Subsystem, the following calls should be made:

1. Unload the namespace and free all resources:

```
Status = AcpiTerminate ();
```

10.1.3 Traversing the ACPI Namespace (Low Level)

This example demonstrates traversal of the ACPI namespace using the low-level Acpi* primitives. The code is in fact the implementation of the higher-level *AcpiWalkNamespace* interface, and therefore this example has two purposes:

1. Demonstrate how the low-level namespace interfaces are used.
2. Provide an understanding of how the namespace walk interface works.

```
ACPI_STATUS
AcpiWalkNamespace (
    ACPI_OBJECT_TYPE    Type,
    ACPI_HANDLE         StartHandle,
    UINT32              MaxDepth,
    WALK_CALLBACK       UserFunction,
```

```

void          *Context,
void          **ReturnValue)
{
    ACPI_HANDLE ObjHandle = 0;
    ACPI_HANDLE Scope;
    ACPI_HANDLE NewScope;
    void        *UserReturnVal;
    UINT32      Level = 1;

/* Parameter validation */

    if ((Type > ACPI_TYPE_MAX) ||
        (!MaxDepth)             ||
        (!UserFunction))
    {
        return ACPI_STATUS (AE_BAD_PARAMETER);
    }

/* Special case for the namespace root object */

    if (StartObject == ACPI_ROOT_OBJECT)
    {
        StartObject = Gbl_RootObject;
    }

/* Null child means "get first object" */

    ParentHandle = StartObject;
    ChildHandle  = 0;
    ChildType    = ACPI_TYPE_ANY;
    Level       = 1;

/*
 * Traverse the tree of objects until we bubble back up to
 * where we
 * started. When Level is zero, the loop is done because we
 * have
 * bubbled up to (and passed) the original parent handle
 * (StartHandle)
 */

while (Level > 0)
{
    /* Get the next typed object in this scope. Null returned
       if not found */

    Status = AE_OK;
    if (ACPI_SUCCESS (AcpiGetObject (ACPI_TYPE_ANY,
        ParentHandle, ChildHandle, &ChildHandle)))
    {
        /* Found an object, Get the type if we are not
           searching for ANY */

        if (Type != ACPI_TYPE_ANY)
        {
            AcpiGetType (ChildHandle, &ChildType);
        }

        if (ChildType == Type)
        {

```



```
/* Found a matching object, invoke the user
   callback function */

Status = UserFunction (ChildHandle, Level,
Context, ReturnValue);
switch (Status)
{
case AE_OK:
case AE_DEPTH:
    break; /* Just keep
           going */

case AE_TERMINATE:
    return ACPI_STATUS (AE_OK); /* Exit now,
                                with OK
                                status */

    break;

default:
    return ACPI_STATUS (Status); /* All others
                                are valid
                                exceptions
                                */

    break;
}
}

/*
 * Depth first search: Attempt to go down another
 * level in the namespace if we are allowed to. Don't
 * go any further if we
 * have reached the caller specified maximum depth or
 * if the user function
 * has specified that the maximum depth has been
 * reached.
 */

if ((Level < MaxDepth) && (Status != AE_DEPTH))
{
    if (ACPI_SUCCESS (AcpiGetNextObject
(ACPI_TYPE_ANY, ChildHandle,
                                0, NULL)))
    {
        /* There is at least one child of this object,
           visit the object */

        Level++;
        ParentHandle = ChildHandle;
        ChildHandle = 0;
    }
}
}

else
{
    /*
     * No more children in this object (AcpiGetNextObject
     * failed),
     * go back upwards in the namespace tree to the
     * object's parent.
     */
}
```

```

        Level--;
        ChildHandle = ParentHandle;
        AcpiGetParent (ParentHandle, &ParentHandle);
    }
}

return_ACPI_STATUS (AE_OK); /* Complete walk, not terminated
                             by user function */
}

```

10.1.4 Traversing the ACPI Namespace (High Level)

This example demonstrates the use of the *AcpiWalkNamespace* interface and other **Acpi*** interfaces. It shows how to properly invoke *AcpiWalkNamespace* and write a callback routine.

This code searches for all device objects in the namespace under the system bus (where most, if not all devices usually reside.) The callback function always returns NULL, meaning that the walk is not terminated until the entire namespace under the system bus has been traversed.

Part 1: This is the top-level procedure that invokes *AcpiWalkNamespace*.

```

DisplaySystemDevices (void)
{
    ACPI_HANDLE          SysBusHandle;

    AcpiNameToHandle (0, NS_SYSTEM_BUS, &SysBusHandle);

    printf ("Display of all devices in the namespace:\n");

    AcpiWalkNamespace (ACPI_TYPE_DEVICE, SysBusHandle, INT_MAX,
                      DisplayOneDevice, NULL, NULL);
}

```

Part 2: This is the callback routine that is repeatedly invoked from *AcpiWalkNamespace*.

```

void *
DisplayOneDevice (
    ACPI_HANDLE          ObjHandle,
    UINT32               Level,
    void                 *Context)
{
    ACPI_STATUS          Status;
    ACPI_DEVICE_INFO     Info;
    ACPI_BUFFER          Path;
    char                 Buffer[256];

    Path.Length = sizeof (Buffer);
    Path.Pointer = Buffer;

    /* Get the full path of this device and print it */

    Status = AcpiHandleToPathname (ObjHandle, &Path);
    if (ACPI_SUCCESS (Status))
    {
        printf ("%s\n", Path.Pointer);
    }
}

```

```
/* Get the device info for this device and print it */  
  
Status = AcpiGetDeviceInfo (ObjHandle, &Info);  
if (ACPI_SUCCESS (Status))  
{  
    printf ("    HID: %.8X, ADR: %.8X, Status: %x\n",  
           Info.HardwareId, Info.Address,  
           Info.CurrentStatus);  
}  
  
return NULL;  
}
```

10.2 Implementing the OS Services Layer

10.2.1 Parameter Validation

In all implementations of the OS Services Layer, the interfaces should adhere to the descriptions in the document as far as the actual interface parameters as well as the returned exception codes. This means that the parameter validation is not optional and that the Core Subsystem layer depends on correct exception codes returned from the OSL.

10.2.2 Memory Management

Implementation of the memory allocation functions should be straightforward. If the host operating system has several kernel-level memory pools that can be used for allocation, it may be useful to know some of the dynamic memory requirements of the ACPI Core Subsystem.

During initialization, the ACPI tables are either mapped from BIOS memory or copied into local memory segments. Some of these tables (especially the DSDT) can be fairly large, up to about 64K. The namespace is built from multiple small memory segments, each of a fixed (but configurable) length. The default namespace table length is 16 entries times about 32 bytes each for a total of 512 bytes per table and per allocation.

During operation, many internal objects are created and deleted while servicing requests. The size of an internal object is about 32 bytes, and this is the primary run-time memory request size.

Several internal caches are used within the core subsystem to minimize the number of requests to the memory manager.

10.2.3 Scheduling Services

The intent of the *AcpiOsQueueForExecution* interface is to schedule another thread. It makes no difference whether this is a new thread created at the time this call is made, or simply a thread that is allocated out of a pool of system threads. Only the ACPI Debugger creates a permanent thread.

10.2.4 Mutual Exclusion and Synchronization

In a single thread environment, the semaphore interfaces can simply return AE_OK. In a multiple thread environment, these interfaces must be implemented with real blocking semaphores since the

mutual exclusion support in the core subsystem relies *completely* upon the proper implementation of this mechanism and these interfaces.

10.2.5 Interrupt Handling

In order to support the OS-independent interrupt handler that is implemented within the Core Subsystem, the OSL must provide a local interrupt handler whose interface conforms to the requirements of the host operating system. This local interrupt handler is a wrapper for the OS-independent handler; it is the actual handler that is installed for the given interrupt level. The task of this wrapper is to handle incoming interrupts and dispatch them to the OS-independent handler via the OS-independent handler interface. When the handler returns, the wrapper performs any necessary cleanup and exits the interrupt.

10.2.6 Stream I/O

The *AcpiOsPrintf* and *AcpiOsVprintf* functions can usually be implemented using a kernel-level debug print facility. Kernel printf functions usually output data to a serial port or some other special debug facility. If there is more than one type of debug print routine, use one that can be called from within an interrupt handler so that Fixed Events and General-Purpose events can be traced.

10.2.7 Hardware Abstraction (I/O, Memory, PCI Configuration)

The intent of the hardware I/O interfaces is to allow these calls to be translated into calls or macros provided by the host OS for this purpose. However, if the host does not provide a hardware abstraction service, these functions can be implemented simply and directly via I/O machine instructions.

This page intentionally left blank.